

AIRTRONICS®

RIVAL 2P 2 CHANNEL SYSTEM

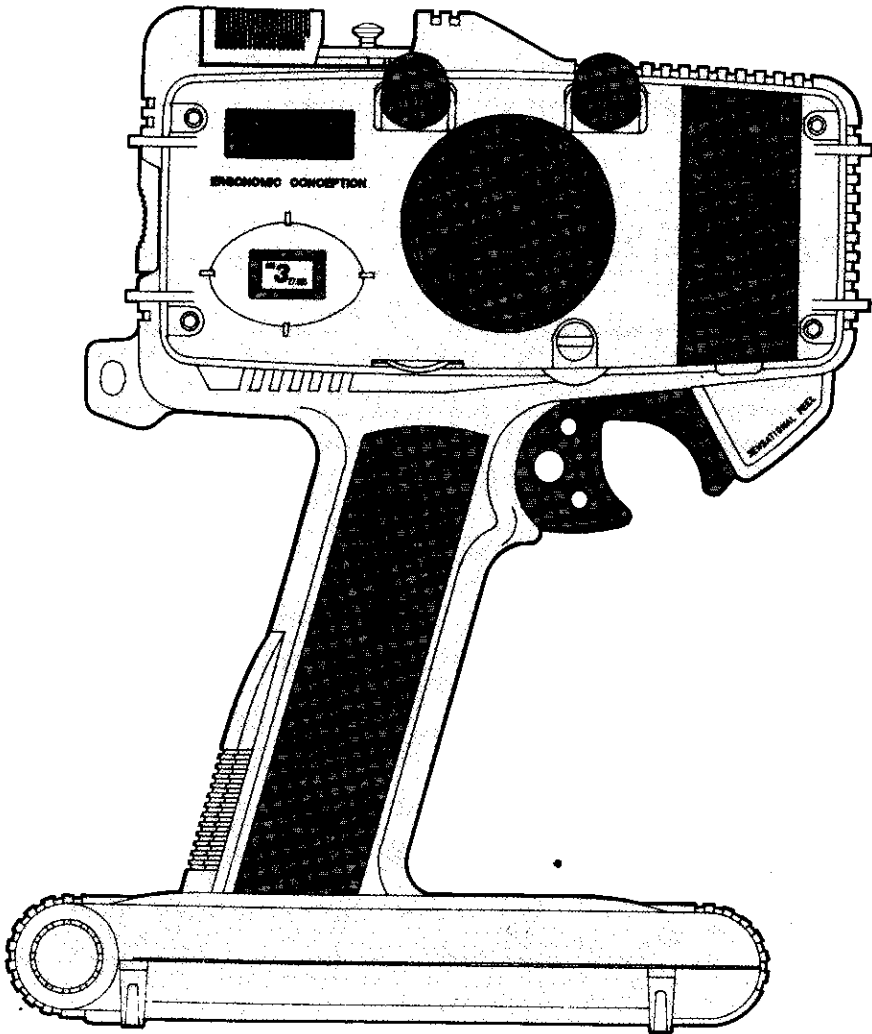

We appreciate your purchase of this new AIRTRONICS RIVAL 2P Radio Control System.

These instructions are intended to familiarize you with the many unique features of this modern, state of the art equipment.

Please read them carefully so you may obtain maximum success and enjoyment from its operation.

Please note that the rival is designed for comfort and precise control of all types of model cars and boats. We wish you the best of success with your radio control system. Enjoy!

SYSTEM FEATURES

- Unique and functional pistol grip transmitter design
- Well balanced for precise control
- Non-slip steering wheel
- Well placed trim and rate functions
- High power output
- Steering dual rate for custom control racing response
- Color LED power indicators for easy reference of battery condition
- Audio battery low voltage alarm
- Retractable transmitter antenna with protective slide cover
- Servo reversing for easy installation
- Smoked hinged cover to protect LED and reverse switches
- Throttle trigger position select (70/30 or 50/50 throw)
- Quick access transmitter crystal (27 MHz only)
- Lightweight, high performance mini receiver
- Receiver includes BEC (Battery Eliminator Circuit) which allows the use of a common power supply for the model and receiver
- High torque and high speed 94102 servos
- Receiver dry battery holder
- NiCd Charger Jack

SYSTEM SPECIFICATIONS

(A) Transmitter

Model:	RV2P
Output power:	500 MW
Modulation:	AM/PPM
Power supply:	8 AA alkaline dry cells DC 12V
Weight:	14.46 ounces
Frequencies:	27 MHz – 6 frequencies 75 MHz – 30 frequencies

(B) Receiver (Mini BEC type)

Model:	92621 (27 MHz) or 92523 (75 MHz)
Modulation:	AM/PPM
Intermediate frequency:	455 KHz
Power supply:	DC 6.0 – 8.4 V
Dimensions:	1.9" (L) × 1.3" (W) × .75" (H)
Weight:	1.13 ounces

(C) Servo

Model:	94102 Heavy duty standard servo × 2
Power supply:	6.0 V through BEC receiver
Dimensions:	1.54" (L) × .79" (W) × 1.42" (H)
Weight:	1.59 ounces
Speed:	0.18 seconds at 6.0 V for 60 degrees rotation
Torque:	50 oz./inches at 6.0 V

(D) Accessories

97004 BEC switch harness
Frequency flag
Receiver dry battery holder
Instruction Manual

(E) Options

96315 Contender speed controller with reverse
96720 whole grip pad
99104 Deluxe wrist strap

TRANSMITTER FUNCTIONS AND OPERATIONS

Antenna (Part number 99108)

Push back the slide cover to expose antenna. Pull antenna up until it locks into position, then extend antenna to its full length when operating the system. Failure to do so can cause loss of control.

Dual Rate Trim

By turning this knob you can vary the amount of steering rate while operating the model. Turning the knob clockwise reduces the amount of steering travel, allowing less steering movement for more precise control.

Power switch

The power switch slides up to turn on the transmitter. When operating your model always turn on your transmitter before the receiver. This will prevent the model from accidentally running away.

Wrist Band Hook

Attachment point for optional 99104 Deluxe Wrist Strap.

Transmitter crystal

The transmitter crystal can be removed to change frequencies (27 MHz only). Use only genuine AIRTRONICS crystals to insure proper operation.

Throttle Trigger

Pull back for forward throttle. Push forward for reverse throttle/brake.

Throttle Trim

This trim dial is used to adjust the neutral point for throttle/brake operation.

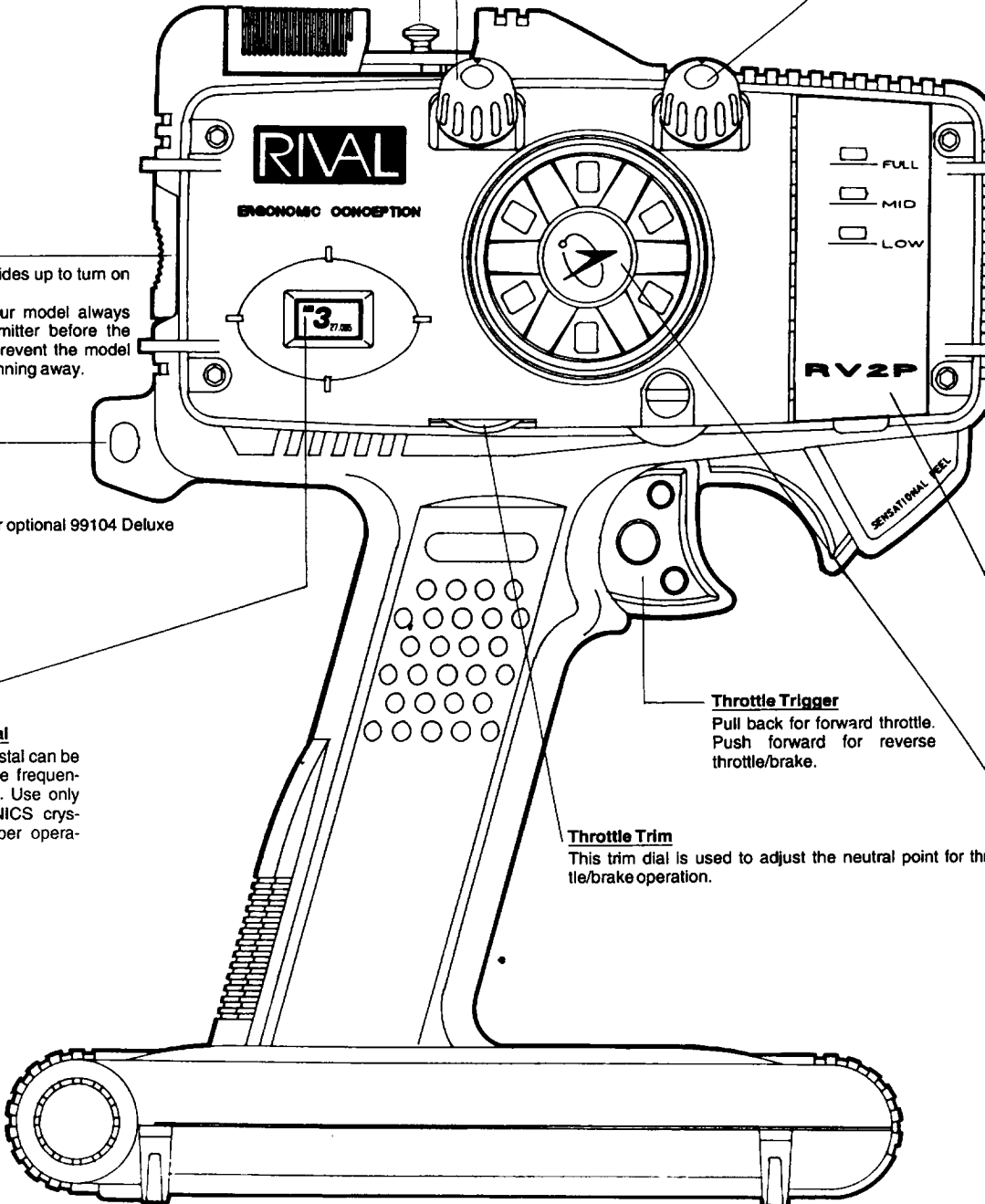

Battery Cover

Slide open in position indicated by arrow to install or replace batteries.

Steering Trim

This trim knob is used to adjust the neutral position of your model's steering control.

If the model drifts to the right or left while running, use the trim knob to make it run straight.

After you run the model, adjust your steering linkage so the trim knob is in the center position for normal operation.

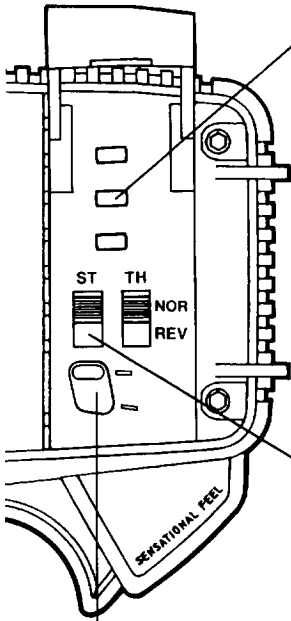

Reverse Switches

In most models, you should leave these switches in the nor or normal position.

When the direction of steering or throttle movement is opposite from the direction of steering wheel or trigger movement, move the switch to the rev or reverse position. This will reverse the direction of servo movement and allow you to operate the model in the normal fashion.

Throttle Trigger Adjustment Switch

Depress and move this switch to change the throttle trigger position from 50/50 (forward/reverse) to 70/30 (forward/reverse).

Protect Cover

Swing upward for access to reverse switches and throttle trigger position switch.

Steering Wheel

Turn clockwise to make the model turn right. Turn Counter clockwise to make the model turn left.

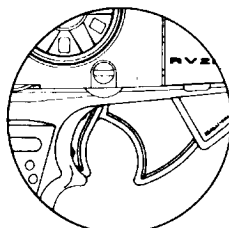

FORWARD

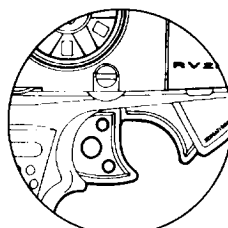

NEUTRAL

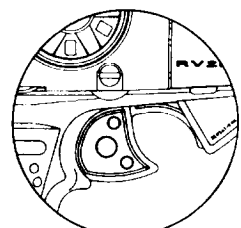

BACKWARD

LED Power Indicators

These color indicators will give you a visual reference for the condition of the transmitter batteries.



GREEN All three indicators (2 green and 1 red) will be lit when the power is on and the batteries are in their best condition. This is the normal operating condition.



GREEN Two indicators (1 green and 1 red) will be lit when the power is on and the batteries are losing capacity. Use caution when operating your model, and replace the batteries as soon as possible.



RED One indicator (red) will be lit when the power is on and the batteries are dead or too weak to power the transmitter. Do not attempt to operate your model, and replace the batteries immediately.



RED If the batteries are improperly installed, the LED indicators will not be lit. Check your battery installation and/or individual batteries.

Audio Low Power Alarm

When the batteries are low, an alarm will sound to warn you. Replace the batteries immediately.

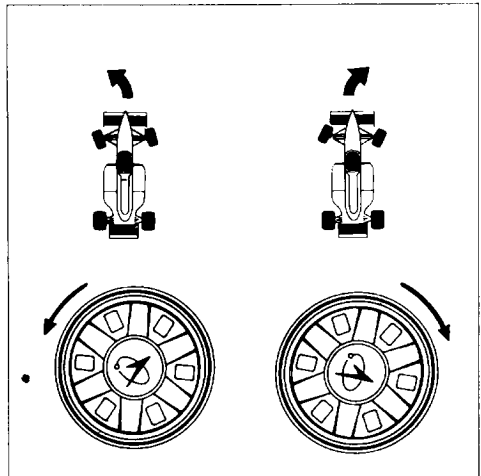

TRANSMITTER BATTERY INSTALLATION

1) Press down on the battery cover and slide in the direction of the arrow to remove.

2) Install 8 pieces "AA" size alkaline batteries as indicated. Make sure to match the polarity (+ and -) as shown in the battery compartment, or the transmitter will not function.

3) Install the battery cover in place, and slide to close.

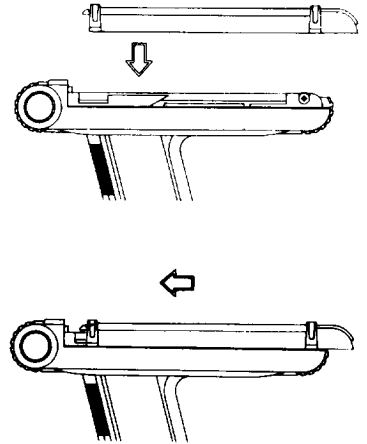
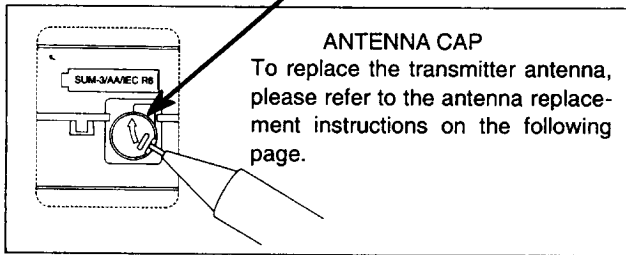
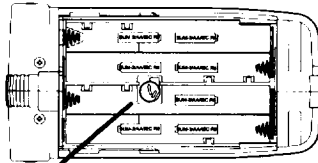
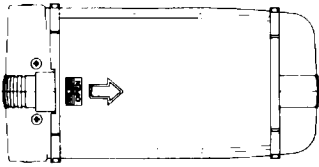

Warning: Improper installation of transmitter or receiver batteries can cause serious damage to your system.

RECEIVER AND SERVO CONNECTIONS

Your RIVAL R/C system is equipped with a BEC receiver to eliminate the need for a separate battery receiver pack, but you can use a separate power supply if desired for your particular model.

The following diagram shows a typical connection for the servos and receiver.

Note that the receiver antenna should be located at least 2" (50 mm) away from the servo leads and switch. In electric cars, we recommend that it be at least 4" (100 mm) from the electric motor.

Extend the receiver antenna to the full length. Failure to do so will cause loss of control. Do not cut or bend the receiver antenna.

Be careful to avoid any metal parts coming in contact with the servo connectors as this will affect the performance. Insulate the connectors with tape or use tie wraps to avoid contact with metal car chassis.

Please follow the model manufacturers' recommendations for the correct installation of your radio system in your car or boat.

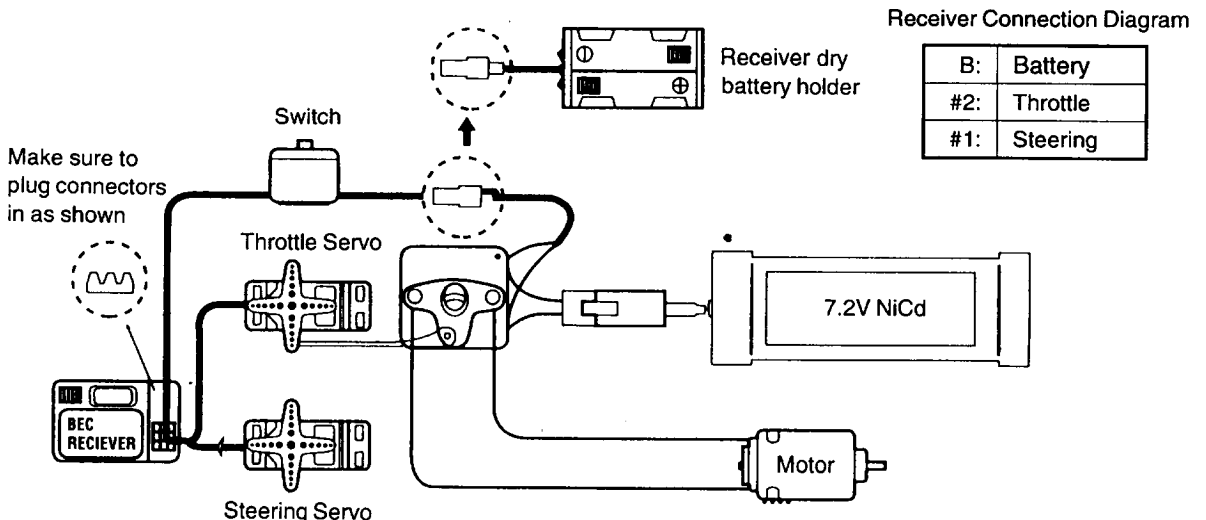

TRANSMITTER ANTENNA REPLACEMENT

- 1) Remove the battery cover from the bottom of the transmitter and remove the batteries. Using a pen or small screwdriver, slide the antenna cap in the direction shown to expose the antenna.
- 2) Press down on the top of the antenna until it appears at the bottom of the transmitter.
- 3) Remove the antenna from the bottom of the transmitter.

We will followings drawings on the RIVAL 2P manual, so please confirm by return.

- 4) Remove the spacer and nut from the bottom of the defective antenna and install them on the new antenna (part number 99108).
- 5) Insert the new antenna from the bottom of the transmitter and push up until the bottom of the antenna is partially exposed.
- 6) Close the antenna cap using a pen or small screwdriver. Make sure that the antenna cap is completely closed before operation. Install the batteries and battery cover. Make sure to extend the antenna to its full length when operating the system.

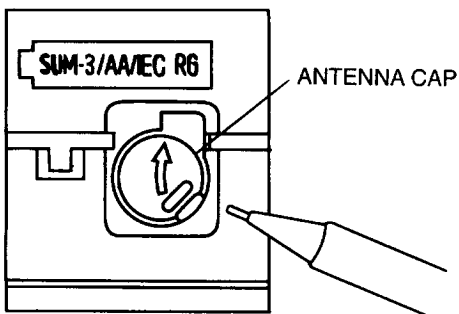
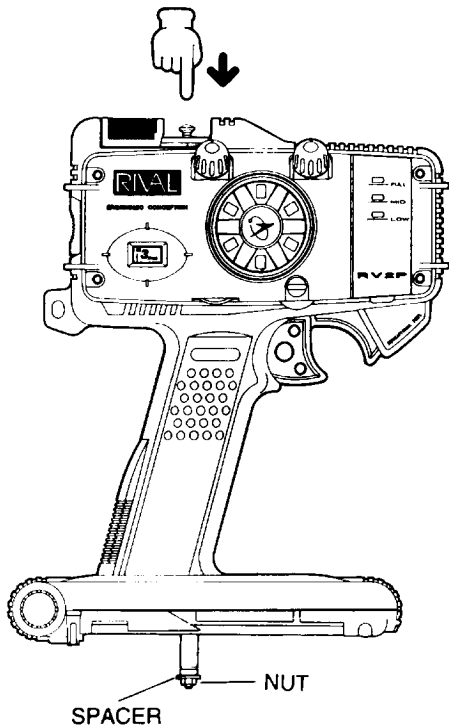

Troubleshooting Guide

If your radio system does not operate properly, please check the following items:

- Make sure the batteries are properly installed, and check the polarity (+ and -) again.
- Check that both the transmitter and receiver power switches are in the ON position.
- Check the LED Power Indicators and make certain that all three are on. If not, replace the batteries.
- Make sure all the receiver and servo connections are tight.
- Make sure that the proper frequency crystals are installed in the transmitter and receiver.

WARNINGS

DO NOT OPERATE YOUR SYSTEM IF SOMEONE ELSE IS ON YOUR FREQUENCY AT THE SAME TIME.

YOUR MODEL CAN CAUSE SERIOUS DAMAGE OR INJURY SO PLEASE USE CAUTION AND COURTESY AT ALL TIMES.

DO NOT EXPOSE THE RADIO SYSTEM TO WATER OR EXCESS MOISTURE.

PLEASE WATER PROOF THE RECEIVER AND SERVO'S BY PLACING THEM IN PLASTIC BAGS OR A WATER TIGHT RADIO BOX WHEN OPERATING R/C BOAT MODELS.

IF YOU HAVE LITTLE OR NO EXPERIENCE OPERATING R/C MODELS, WE STRONGLY RECOMMEND YOU SEEK THE ASSISTANCE OF EXPERIENCED MODELERS OR YOUR LOCAL HOBBY SHOP FOR GUIDANCE.

Warranty Information

For warranty and service information regarding your RIVAL 2P, please refer to the *Installation Fundamentals and Guidelines* Manual included with your system.



1185 Stanford Court, Anaheim, CA. 92805

Tel: (714) 978-1895