

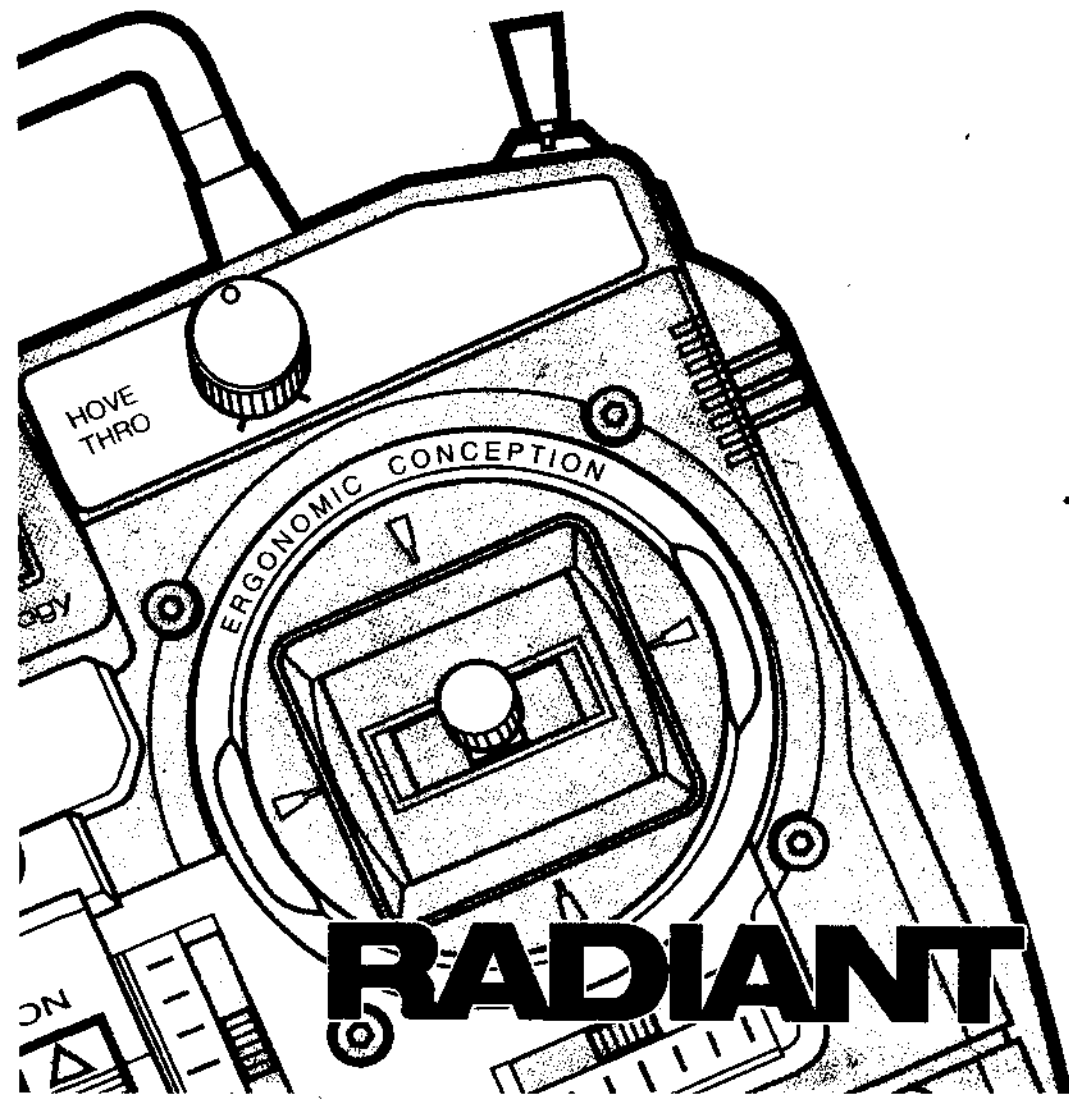

# RADIANT 6P/6H

COMPUTER RADIO SYSTEMS OPERATING MANUAL

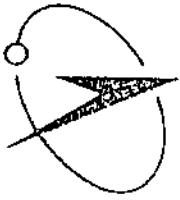



# **AIRTRONICS<sup>®</sup> INC**

~~15311 Barona Parkway, Irvine, California, 92618 (714) 727-1474 FAX (714) 727-1062~~

## **ADDENDUM TO RADIANT 6P/6H OPERATING MANUAL**

1. The Airborne System Connection diagram shown on page 10 of the Radiant 6P/6H operating manual shows receiver connections for the Trainer 2 output; i.e., the Elevator and Throttle channels are incorrect. Train 1 is for use with Vanguard VG4R, VG6DR or VG7P FM transmitters. Train 2 is for use with a Quasar 6A/6H or Infinity 660. Therefore, we request you switch the notations on the diagram to show Elevator as Channel #1 and Throttle as Channel #3. These corrections should also be made to pages 21, 22, 34 and 35. We apologize for any confusion this may have caused.
2. The 6P and 6H include a lithium battery to maintain your program memory when the transmitter is switched off. The battery is rated for approximately five years expectancy. To allow a safety margin we recommend you return your transmitter every three years to Airtronics or to an authorized service station for battery replacement. When the lithium battery no longer operates, the transmitter will revert to default settings. This cannot happen while you have the transmitter turned on. It might be advisable to write down your program settings so you will have them available for future reference.

# 1. RADIANT TRANSMITTER FEATURES

## RADIANT TRANSMITTER FEATURES

The RADIANT 6P and 6H narrow band FM systems are designed for use by Airplane or Helicopter pilots who demand a quality product. Both are remarkably easy to set up, program and use.

### RADIANT Series Standard Features

The following features are standard for both the RD6P and RD6H Models:

- End Point Adjustments (EPA) on all channels
- Dual Rate on Aileron and Elevator
- 3 Model Memory
- Sub Trim on all proportional channels
- Servo Reversing on all channels
- Trainer System compatible with VANGUARD 4, 6, 7ch FM, QUASAR and INFINITY 660
- High Capacity Transmitter and Receiver NiCd Batteries
- ESV Meter
- Narrow Band Dual Conversion FM Receiver
- Precision Gimbal Assemblies
- Adjustable stick Tension and Length
- Programmable Key Lock

### RD6P Features

- Aileron > Rudder Coupling
- Throttle > Elevator Mixing
- Throttle > Rudder Mixing
- Elevator > Flap Mixing
- Flap > Elevator Mixing
- 2 Stage Flap System
- Flaperon
- Spoileron/Crow
- Aileron Differential Adjustment
- Delta (Elevon)
- V-tail

### RD6H Features

- Three Pitch Curves
- Idle Up
- Throttle Hold with Inhibit.
- Revolution Mixing
- Hovering Pitch Adjustment
- Hovering Throttle Adjustment
- Gyro Select
- 1000 mAh Receiver NiCd

### RADIANT TRANSMITTER SPECIFICATIONS:

Transmitter Type:	— 6 Channel FM/PPM Dual Stick
Dimensions:	— W 7.5" x H 6.0" x D 2.5"
Weight:	— 23 Ounces
Power Output:	— 600 MW
Frequencies:	— 50 or 72 MHz
Modulation:	— PPM/FM
Power Supply:	— 9.6 Volt, 600 mAh NiCd
Current Drain:	— 200MA
Temperature Range:	— 0-160 degrees F.
Pulse Width:	— 1.5 ms (nominal)
Receiver Type:	— 92765 FM 6 ch. Super Narrow Band Receiver
Sensitivity:	— 1.5 Microvolts
Receiver Power Supply:	— 4.8 Volt, 600 mAh NiCd

## 2. TABLE OF CONTENTS

page	page
1..... Introduction	11..... 12. Transmitter Battery Removal
2..... 1. RADIANT Transmitter Features	12..... 13. Transmitter Antenna Caution
3..... 2. Table of Contents	12..... 14. Control Stick Adjustment
4..... 3. Safety First	13..... 15. Spring Tension Adjustment
5..... 4. Academy of Model Aeronautics	14..... 16. Trainer System
6..... 5. Aircraft Frequencies	16..... 17. Replacement of Antenna
7..... 6. FAA Guidelines	17..... 18. Using the RADIANT Micro-Processor
8..... 7. Unpacking and Charging	
8..... 8. Airborne Components	
8..... 9. Connector Wiring	
9..... 10. Transmitter Expanded Scale Voltmeter (ESV)	
10..... 11. Airborne System Connection	

### RADIANT 6H

page	page
18..... 19. Transmitter Layout and Capabilities	24..... 26. S-TRM (Sub Trim)
20..... 20. Key Lock	24..... 27. Throttle Curve
20..... 21. M-SEL (Model Select)	25..... 28. Pitch Curve
20..... 22. REV (Servo Reverse)	26..... 29. Hold (Throttle Hold)
21..... 23. DR (Dual Rate)	26..... 30. ID-UP (Idle UP)
22..... 24. EPA (End Point Adjust)	28..... 31. HVP (Hovering Pitch)
23..... 25. RV-MX (Revolution Mixing)	29..... 32. HVT (Hovering Throttle)

### RADIANT 6P

page	page
30..... 33. Transmitter Layout and Capabilities	38..... 43. FLAPRN (Flaperon)
32..... 34. Key Lock	39..... 44. DIFF (Differential Ailerons)
32..... 35. Installation Guidance	39..... 45. FLAP 1
33..... 36. M-SEL (Model Select)	40..... 46. FLAP 2
34..... 37. REV (Servo Reverse)	40..... 47. EL → FL (Elevator-To-Flap Mixing)
35..... 38. D/R (Dual Rate)	41..... 48. FL → EL (Flap-To-Elevator Mixing)
35..... 39. EPA (End Point Adjust)	41..... 49. TH → RU (Throttle-To-Rudder Mixing)
36..... 40. S-TRM (Sub-Trim)	42..... 50. TH → EL (Throttle-To-Elevator Mixing)
37..... 41. AI → RU (Aileron-To-Rudder Coupling)	43..... 51. DELTA MIX (Elevons)
37..... 42. SPOIRN (Spoileron)	43..... 52. V-TAIL

### **3. SAFETY FIRST!**

"SAFETY FIRST!" is not just a slogan when it comes to radio controlled models. The key to R/C pleasure is proper use of your radio system and all other modeling components. If you fail to follow instructions, fail to heed warnings given, or fail to install and operate your system according to the instructions provided with the unit, the result may be the partial or total destruction of your system and injury to yourself or to the person or property of others. For your own safety and the safety of others you must recognize that radio controlled models are not harmless toys and can become dangerous missiles if carelessly or improperly flown. **REMEMBER THAT YOU ARE RESPONSIBLE FOR THE SAFETY OF ALL SPECTATORS AND MAY BE HELD LIABLE FOR ANY DAMAGE OR INJURY CAUSED BY YOUR MODEL.** Radio control equipment and models are generally attractive, inviting, and exciting in looks and performance. Realize that young people and inexperienced adults may try to operate the equipment without understanding the dangers to themselves or others. It is your responsibility to guard against unknowing hands for their protection as well as for the safety of your equipment and model.

**ALWAYS INSTALL YOUR RADIO CONTROL SYSTEM CORRECTLY, MAINTAIN IT PROPERLY AND BE CERTAIN THAT YOU CAN FLY WELL ENOUGH TO CONTROL YOUR AIRCRAFT AT ALL TIMES.**

**DO NOT FLY** where your model could injure any person or property. **DO NOT FLY OVER THE HEADS OF SPECTATORS OR PERSONS IN THE AREA OF YOUR FLYING FIELD.** This includes taking off, actual flight and landing. Keep everyone, except experienced and knowledgeable persons who are assisting you in flying, away from your model even when it is on the ground and you are preparing to fly.

**DO NOT FLY** unless an experienced instructor has completely checked over your model and radio installation and test flown the model for you.

**DO NOT FLY** if you are a newcomer to R/C unless you have an experienced instructor who will fly with you until you have learned to fly competently by yourself.

**DO NOT FLY** in adverse weather conditions. Strong winds, for example, may cause loss of control of your aircraft leading to injury or damage to yourself or others.

**DO NOT FLY** unless your frequency is clear. Only one person can use each frequency at a time.

**WARNING:**

**IF YOU DELIBERATELY OR ACCIDENTALLY TURN ON YOUR TRANSMITTER WHILE ANOTHER MODEL IS FLYING ON THE SAME FREQUENCY, THAT MODEL WILL GO OUT OF CONTROL.**

## 4. ACADEMY OF MODEL AERONAUTICS

### ACADEMY OF MODEL AERONAUTICS

5151 East Memorial Drive

Muncie, Indiana 47302

The Academy of Model Aeronautics (AMA) is a national organization representing modelers in the United States. We urge you to examine the benefits of membership, including liability protection in the event of certain injuries. The Academy has adopted simple and sane rules which are especially pertinent for radio controlled flight as the **OFFICIAL AMA SAFETY CODE**, which we have partially reprinted below:

1. I will not fly my model in competition or in the presence of spectators until it has been proven to be airworthy by having been previously successfully flight tested.
2. I will not fly my model higher than approximately 400 feet within 3 miles of an airport without notifying the airport operator. I will give the right of way to, and avoid flying in the proximity of, full scale aircraft. When necessary, an observer shall be utilized to supervise flying to avoid having models fly in the proximity of full scale aircraft.
3. Where established, I will abide by the safety rules for the flying site I use, and I will not willfully and deliberately fly my models in a careless, reckless, and/or dangerous manner.
4. I will have completed a successful radio equipment ground range check before the first flight of a new or repaired model.
5. I will not fly my model aircraft in the presence of spectators until I become a qualified flyer, unless assisted by an experience helper.
6. I will perform my initial turn after take off away from the pit or spectator areas, unless beyond my control.
7. I will operate my model using only radio control frequencies currently allowed by the Federal Communications Commission. (See Chart Below) Only properly licensed amateurs are authorized to operate equipment on amateur band frequencies.

## 5. AIRCRAFT FREQUENCIES

### 72 MHZ BAND

Ch.#	Freq.	Ch.#	Freq.	Ch.#	Freq.	Ch.#	Freq.	Ch.#	Freq.
11	72.010	21	72.210	31	72.410	41	72.610	51	72.810
12	72.030	22	72.230	32	72.430	42	72.630	52	72.830
13	72.050	23	72.250	33	72.450	43	72.650	53	72.850
14	72.070	24	72.270	34	72.470	44	72.670	54	72.870
15	72.090	25	72.290	35	72.490	45	72.690	55	72.890
16	72.110	26	72.310	36	72.510	46	72.710	56	72.910
17	72.130	27	72.330	37	72.530	47	72.730	57	72.930
18	72.150	28	72.350	38	72.550	48	72.750	58	72.950
19	72.170	29	72.370	39	72.570	49	72.770	59	72.970
20	72.190	30	72.390	40	72.590	50	72.790	60	72.990

### 6 METER AMATEUR BAND

Ch.#	Freq.
00	50.800
01	50.820
02	50.840
03	50.860
04	50.880
05	50.900
06	50.920
07	50.940
08	50.960
09	50.980

## 6. FAA GUIDELINES

### FEDERAL AVIATION ADMINISTRATION

The Federal Aviation Administration has announced guidelines for operation of model aircraft. We are reprinting these guidelines here and encourage you to study and follow them.

1. Purpose: This advisory circular outlines safety standards for the operators of model aircraft and encourages voluntary compliance with these standards.
2. Background: Attention has been drawn to the increase in model operations, and the need for added caution in the case of free flight and radio controlled types to avoid creating a noise nuisance or a potential hazard to full-scale aircraft and persons and property on the surface.
3. Operating Standards: Modelers, generally, are concerned about safety and do exercise good judgment when flying model aircraft. However, in the interest of avoiding undue criticism from affected communities and airspace users, **COMPLIANCE WITH THE FOLLOWING STANDARDS IS ENCOURAGED BY OPERATORS OF RADIO CONTROLLED AND FREE FLIGHT MODELS.**
  - A. Exercise vigilance for full scale aircraft (get other people to help if possible) so as not to create a collision hazard.
  - B. Select an operating site at a sufficient distance from populated areas to avoid creating a noise problem or potential hazard.
  - C. Do not fly higher than 400 feet above the surface.
  - D. Do not operate closer than three miles from the boundary of an airport unless permitted to do so by the appropriate air traffic control facility in the case of an airport for which a control zone has been designated, or by the airport manager in the case of other airports.
  - E. Do not hesitate to ask for assistance in complying with these guidelines at the airport traffic control tower, or air route center nearest the site of the proposed operations.

### A FINAL NOTE ON SAFETY

The basic safety precautions outlined above are for your safety, the safety of others, and the safety of your equipment. Consider carefully all of what has been stated and obey all precautions in this manual, as well as any others appropriate to your particular activity. And remember that good common sense must also be used at all times during the operation of your equipment.



## 7. UNPACKING AND CHARGING

### PACKAGING

The packaging of your Airtronics RADIANT has been especially designed for the safe transportation and storage of the radio's components. After unpacking your radio, **DO NOT DISCARD THE CONTAINERS**. You should set the packaging aside for use if you ever need to send your radio in for service, or to store your radio in if you do not plan to use it for an extended period of time.

### BATTERY CHARGING

The first thing you should do after unpacking your RADIANT is to charge the transmitter and receiver batteries. The charging procedure is completely explained in Section IV, page 9 of the **INSTALLATION FUNDAMENTALS AND GUIDELINES MANUAL** included with your radio.

## 8. AIRBORNE COMPONENTS

### AIRBORNE COMPONENTS

While the system's batteries are charging, you can familiarize yourself with the airborne portion of your radio. The airborne portion of the radio refers to any components which are mounted in your plane and carried aloft when you fly. The airborne components consist of the receiver, which receives the signals from the transmitter, decodes them, and relays the commands to the servos; the servos, which are simply electronically-controlled motors used to move the controls of the plane; the battery pack, which provides power for the receiver and servos to operate; and the switch harness which allows you to turn the airborne package on and off.

## 9. CONNECTOR WIRING

### CONNECTORS

The connectors on your Airtronics System are rugged but should be handled with care. There are three socket contacts in the servo connector, numbered 1 through 3. The #1 is the signal pin, #2 is negative and #3 (Red) is positive. The Plug configuration is shown below. If you are using an FM receiver where the connectors are plugged into the end of the receiver, be certain that the #3 pin is toward the bottom of the receiver. When you are using the FM 6 channel receiver where the connectors plug into the top of the receiver, the #3 pin should be toward the outside edge of the receiver. Do not attempt to force the plug into the receiver; properly align each servo plug and it will move into place.



## **10. TRANSMITTER EXPANDED SCALE VOLTMETER(ESV)**

### **TRANSMITTER ESV METER**

The meter on the front of the RADIANT TRANSMITTERS IS AN EXPANDED SCALE VOLTMETER (ESV) and is an indication of the state of charge of the transmitter battery. With the transmitter fully charged the meter will read in the upper portion of the silver section on the meter face. If the meter reads in the orange portion it indicates that the battery is marginally discharged. A reading in the red indicates the battery is discharged below an acceptable level.

When the transmitter has just been fully charged you should get a reading in the high silver. Make a note of where the needle moves to after a full charge. If in the future there is a substantial change in the position the needle assumes right after a full charge, it may be an indication of a drop in battery performance and the unit should be returned to Airtronics for inspection. If you get a reading in the red or orange after a full charge it is an indication of defective cells and the battery must be replaced. If there is no movement of the meter when the transmitter is first turned on the battery is most likely completely discharged. Charge the battery pack as described in Section IV of the **INSTALLATION FUNDAMENTALS AND GUIDELINES MANUAL**. After approximately 15 minutes of operation the reading will drop to the lower portion of the silver. This is normal, since the battery in the transmitter will actually be higher than 9.6 volts when first taken off charge. The meter is calibrated so that a 9.6 volt reading is in the lower portion of the silver area.

**DO NOT ATTEMPT TO OPERATE A TRANSMITTER UNLESS THE METER READS IN THE SILVER WITH THE ANTENNA FULLY EXTENDED. IF YOU NOTICE THE METER READING HAS DROPPED INTO THE ORANGE WHILE FLYING, LAND IMMEDIATELY. A TRANSMITTER WHOSE PERFORMANCE HAS DROPPED MAY NOT SEND THE SIGNALS REQUIRED TO ADEQUATELY AND SAFELY CONTROL THE MODEL, RESULTING IN A POSSIBLE CRASH.**

#### **NOTE:**

When you first unpack your radio you should charge the transmitter and receiver batteries for 24 hours. Subsequent re-charges should require only 12 hours.

## 11. AIRBORNE SYSTEM CONNECTION

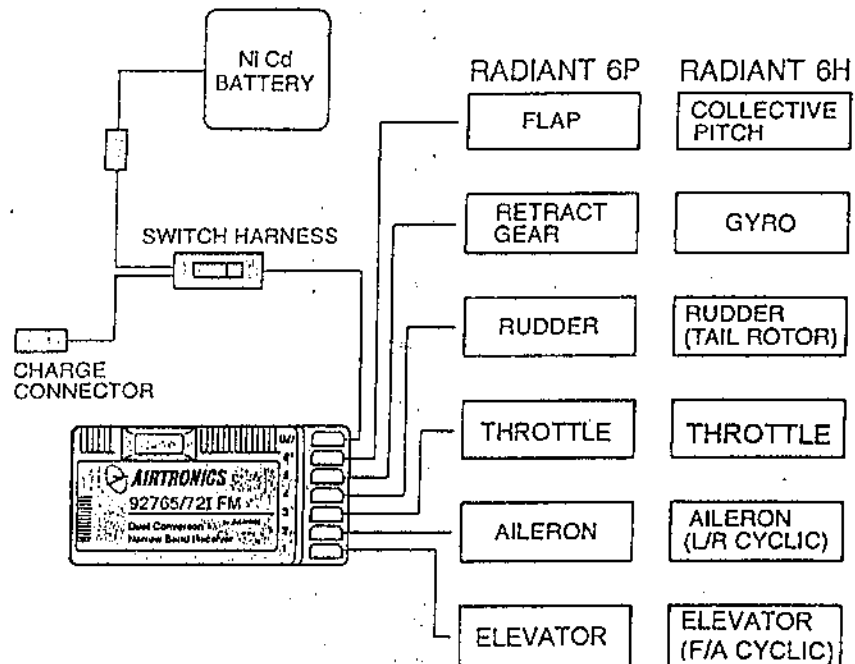

This diagram shows how to connect the components of your system together. Note the servo and switch harness plugs are inserted in the receiver so that pin #3 is towards the outside of the receiver. At this point, your objective is to get the system operating on your workbench. Once connected, you must then refer to the corresponding diagram for your system showing the transmitter control sticks' function.

### SPECIAL NOTE:

Trainer 1 output is shown above for use with Vanguard FM/PPM transmitters. If you select Trainer 2 the ELEVATOR & THROTTLE channels are switched for use with Quasar or Infinity 660 transmitters.

## 12. TRANSMITTER BATTERY REMOVAL

### TRANSMITTER BATTERY REMOVAL

The battery pack in your RADIANT TRANSMITTER can easily be removed and replaced with a fully charged pack to extend operating time.

Additional packs are sold separately as an accessory item under the Airtronics P/N 95010.

To remove the pack, push down on the two ears of the battery door located on the back of the transmitter. The door can then be removed and the NiCd battery pack unplugged. Reverse the procedure to install a new pack.

### CAUTION:

Observe the correct polarity when plugging in the pack. The lead with the RED trace is towards the top of the transmitter.

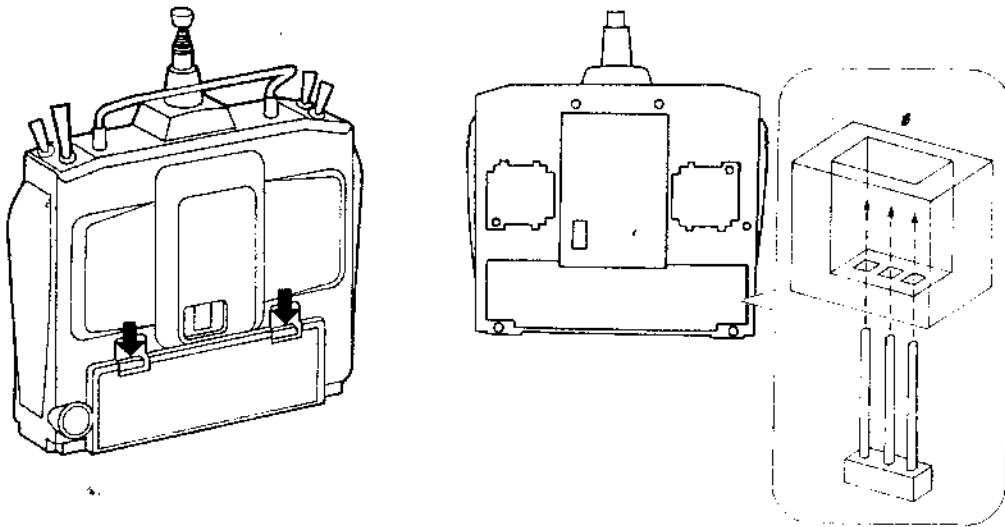

## 13. TRANSMITTER ANTENNA CAUTION

### TRANSMITTER ANTENNA CAUTION

The antenna on your RADIANT transmitter is not connected when it is fully retracted into the case. You must pull it up until it snaps into place. There then will be approximately 4 1/2 inches above the top of the case. Prior to flying, extend the antenna to its full length.

## 14. CONTROL STICK ADJUSTMENT

### CONTROL STICK LENGTH ADJUSTMENT

The sticks in your RADIANT are adjustable in length and spring tension to allow you to tailor their feel to your personal preference. To adjust stick length, hold Part B with your fingers and unscrew Part A counterclockwise to loosen the two pieces. Now screw Part A in or out to the desired position, and lock it in place by screwing Part B against it. It is best to leave at least four threads inside Part A when screwed out to its longest length for the best mechanical security. Do not overtighten when you screw the two parts together.

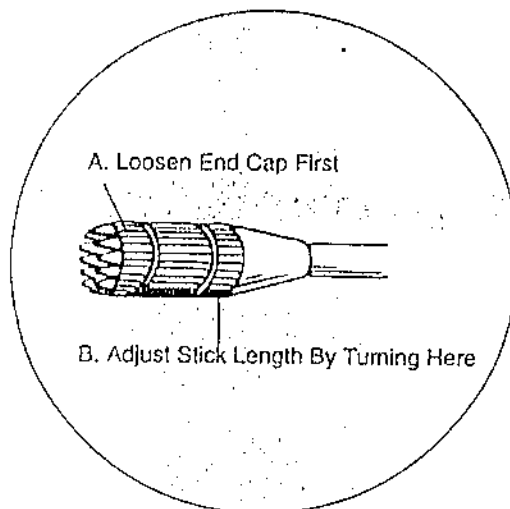

## 15. SPRING TENSION ADJUSTMENT

### SPRING TENSION

To adjust the spring tension of the sticks you need to take off the back of the transmitter. First remove the battery pack. Remove the six screws that hold the case back in place, four on the back near the top of the transmitter, two at the lower back. Once the screws are removed swing the back of the case away from the transmitter, being careful of the trainer plug wiring.

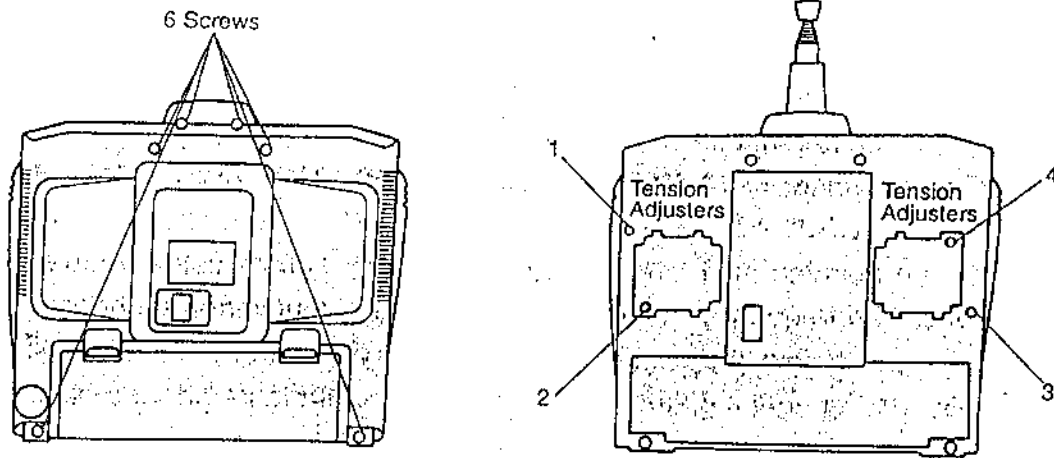

There are four locations for the stick adjustment screws. Your RADIANT will only have three screws installed because the stick controlling the throttle is ratcheted and has no tension adjustment. The #1 and #3 screws adjust the tension for the vertical motion of each stick. The #2 and #4 screws adjust the tension for the horizontal motion of each stick. To make the tension adjustment, use a small Phillips type screwdriver to turn the adjustment screws. Turning the screw clockwise will increase the stick tension, turning it counterclockwise will decrease the tension.

Once you have completed your stick adjustments, replace the case back and install the battery pack.

## 16. TRAINER SYSTEM

### TRAINER SYSTEM

The Trainer system in the RADIANT transmitter allows you to connect any two Airtronics RADIANT transmitter together or to a VANGUARD 4,6,7channel FM transmitter for the purpose of training a new R/C pilot. The connection between the transmitter is made by plugging an Airtronics standard Trainer System Cable (P/N 97100) into the round connector located on the back of the RADIANT transmitter. The trainer system in the RADIANT will also work with the INFINITY 660 or a QUASAR transmitter when using the Airtronics Computer Trainer System Adapter (P/N 97103) with the standard trainer cable (P/N 97100).

In actual use, one of the two transmitters will serve as the Master and the second transmitter will serve as the Trainer. The Master transmitter is held by the instructing pilot, **AND IS THE TRANSMITTER THAT MUST MATCH THE RECEIVER FREQUENCY INSTALLED IN THE PLANE.** The trainer transmitter is held by the learning pilot, and does not need to be on the same frequency as the plane. The frequency of the Trainer transmitter is unimportant because the switch of the trainer transmitter is **NOT** turned on during instructional flying. Normally during training, the instructor takes the plane off and flies it to altitude. While the spring loaded switch is left in its off position, the Master transmitter will have full control of the model. When the instructor is ready to begin training, he presses and holds the spring loaded switch on his transmitter.

(As long as the instructor holds the switch in the on position, the model will respond to the commands of the Trainer transmitter sticks, allowing the pupil to fly the plane. It is not necessary for the student to hold the switch on the Trainer transmitter.)

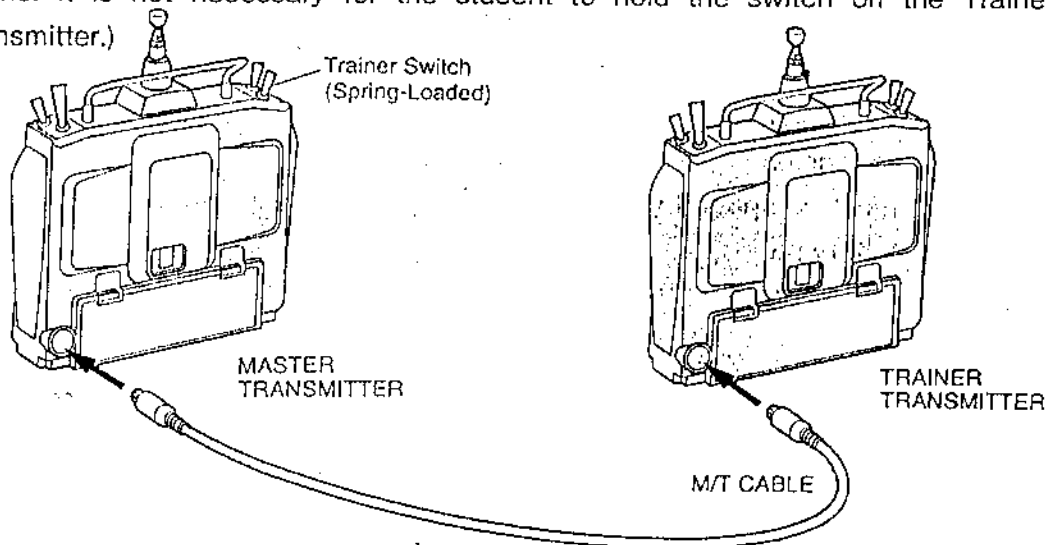

When the instructor wishes to stop training, or if he feels that the student is in a situation that endangers the plane, the instructor can release the spring loaded switch and control of the model will immediately return to the Master transmitter. To use the Trainer system, You must position the cursor over TRAINER on the LCD panel. You then can select either TRAIN 1 OR train 2 using the YES/INC + or NO/DEC-key. TRAIN 1 is for use of the RADIANT transmitter with another RADIANT transmitter or with a VANGUARD 4, 6, or 7channel FM transmitter. TRAIN 2 is for use with a QUASAR or INFINITY660 transmitter.

Plug the trainer cable into the back of both the Master and Trainer transmitter. After the cable is plugged in to both transmitters, turn on the Master transmitter and the model. The cable will energize the encoder section of the Trainer transmitter. Once you have verified that both the Master and Trainer transmitter will control the model when the spring loaded switch is in the appropriate position you are ready to begin training.

**NOTE:**

BOTH transmitters must be programmed identically for the trainer system to function properly. All switch assignments, reversing positions, servo centering and end points and other setting must be identical.

**Master/Trainer Operation**

- Connect the master side (instructor side) transmitter to the trainer transmitter using the trainer cable (P/N 97100 for RADIANT or VANGUARD) (P/N 97103 and P/N 97100 for QUASAR or INFINITY660).
- Turn on the power switch of the master transmitter. Do not turn on the trainer transmitter's switch! If the master transmitter's spring loaded trainer switch is set to ON (by holding it to the right), maneuvering can be performed from the trainee's transmitter. If the master trainer switch is OFF, the master transmitter has control of the model.

**CAUTION:**

The trims of both RADIANT transmitters used for training must be set to the same position. Their LCD settings to include servo direction must also be identical.

When the INF660 is used, set the MODULATION (modulation system) of the INF660 to PPM.



## 17. REPLACEMENT OF ANTENNA

### REPLACEMENT OF ANTENNA

The transmitter antenna, if broken, must be replaced using the following procedure.

- Remove the transmitter battery.
- Remove the 6 screws from the back of transmitter as shown below, and carefully remove the back to avoid breaking the wires to the M/T socket.
- Push the antenna all the way down and withdraw it from the transmitter.
- Turn the plastic stop on the bottom of the antenna counterclockwise (see the figure) using a box wrench (8mm across).
- Fit the plastic stop to the new antenna, and mount the antenna in the transmitter in the reverse order of removal.
- Finally replace the transmitter back and tighten the 6 screws. Do not over tighten!
- Install the transmitter battery and plug it in observing polarity. The lead with the red trace is towards the top of the transmitter.
- Replace the battery cover.

### CAUTION:

When replacing the transmitters back, insure that the battery socket pins provided at the right lower side of PCB fit properly into the hole on the rear lid. Be careful so that pins are not bent.

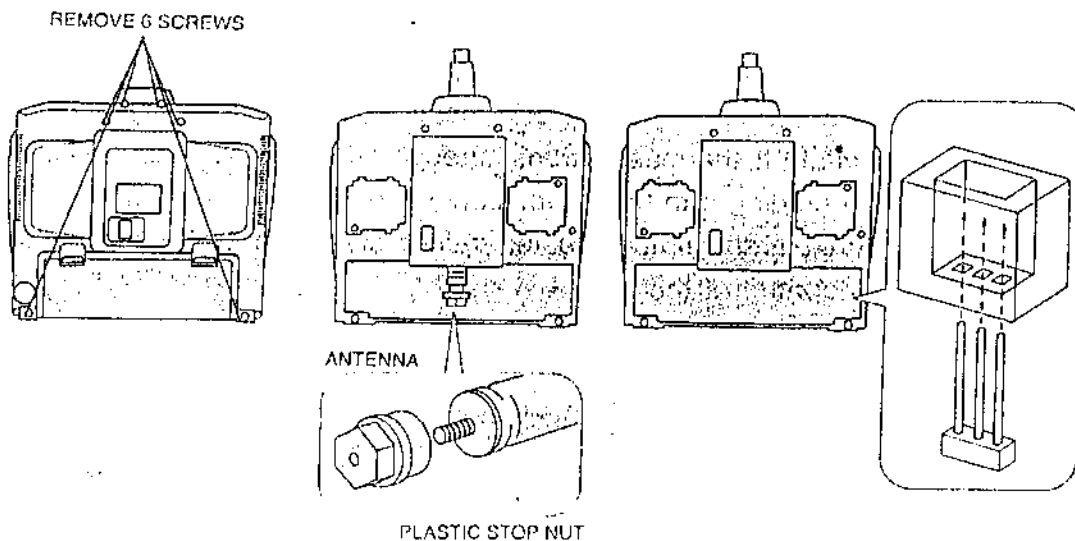

# 18. USING THE RADIANT MICRO-PROCESSOR

## USING THE RADIANT MICRO-PROCESSOR

Airtronics has invested a large amount of design effort to ensure that the capabilities of the RADIANT are as simple as possible to use. The manual has also been written to offer the user complete instructions for each of the aircraft model types that can be controlled with the RADIANT. With patient study of the manual you will find it exceptionally easy to access each of RADIANT'S features. This manual is divided into three sections, one for the introduction, another for the Helicopter RADIANT 6H and one for the Airplane RADIANT 6P. You only need to read the section that pertains to your type of unit.

In most cases all of the programming steps possible with the RADIANT are accomplished through use of the Input Keys. These keys are located next to the LCD display panel, on the bottom face of the RADIANT transmitter. The function(s) of these keys and the panels of the 6P and 6H are shown below.

RADIANT 6P

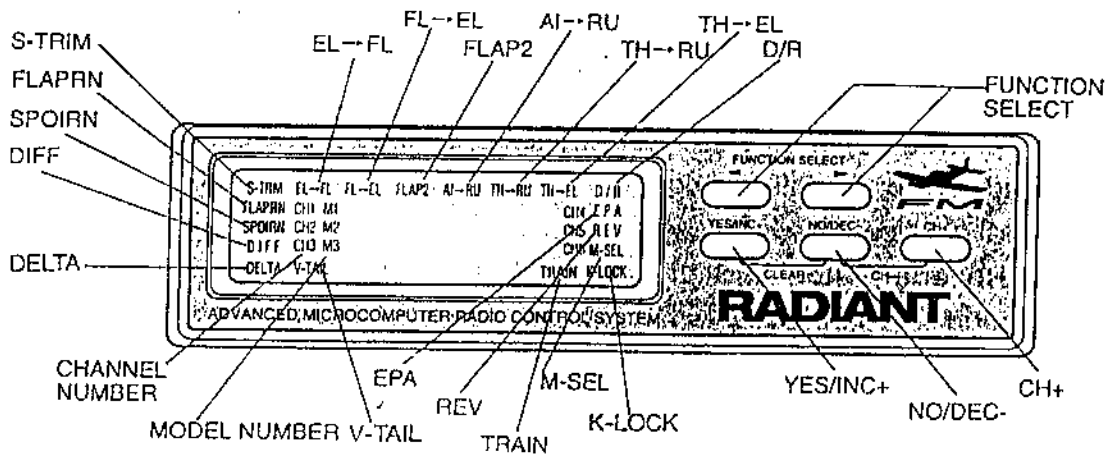

RADIANT 6H

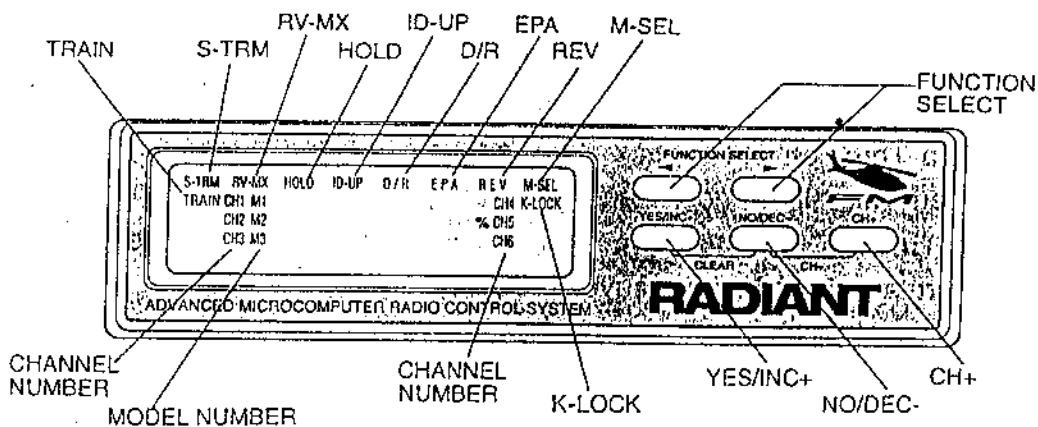

# RADIANT 6H

## 19. TRANSMITTER LAYOUT AND CAPABILITIES

### RADIANT 6H TRANSMITTER CAPABILITIES

- Unlike conventional single model transmitters which use switches and trimmers provided on a trimmer panel to set the functions or make adjustments, the RADIANT COMPUTER 6H transmitter employs a computer system that is capable of making settings on the LCD display with the aid of microcomputer.
- AIRTRONIC'S custom one-chip microcomputer provides the ability to program many functions.
- All the functions for 3 different models can be set and retained in memory. Hence, settings for three models can be made using only one transmitter.
- The aileron and elevator channels have the capability to set **dual rate**, i.e., less throw.
- **Servo reverse** is provided on all channels, so that the servo direction can be easily reversed as required for a specific installation.
- **End point adjustments** are provided for all channels. End points can be set individually for the left and right (upper and lower) sides without changing the neutral position.
- The **Hovering Pitch** function adjusts only the pitch in the hovering state. The **Hovering Throttle** function adjusts only the throttle opening to the amount you require.
- The AIRTRONIC'S original 2-way **revolution mixing** function provides the capability for adjusting rudder mixing.
- The **Sub-Trim** is capable of functioning as an auxiliary trim on all channels except for the gyro channel.
- The **3-point throttle curve** and pitch curve can be set.
- **PITCH CURVE** (EPA on Channel 6, Collective Pitch) The RADIANT 6H permits you to set 3 different pitch curve, i.e., one normal curve, one Idle-Up curve, and a Throttle-Hold setting when you select EPA/Channel 6 on the LCD screen. This allows you to adjust the pitch curve while your engine is idling.
- The **Throttle Hold** function is provided so that it can be used to perform auto-rotation or other maneuvers as desired.
- The **Idle-Up** function provides aerobatic maneuver capability.

# RADIANT 6H TRANSMITTER LAYOUT

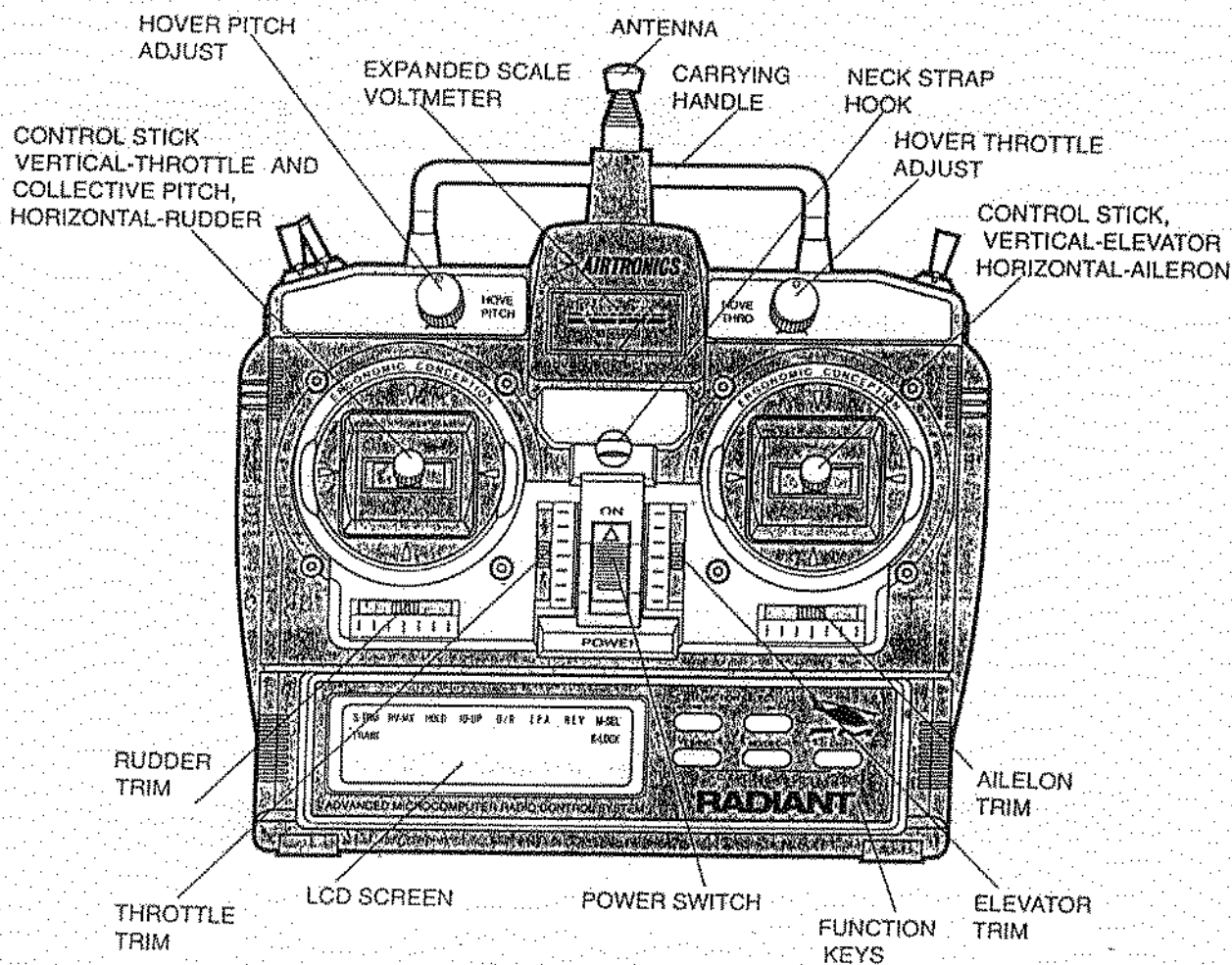
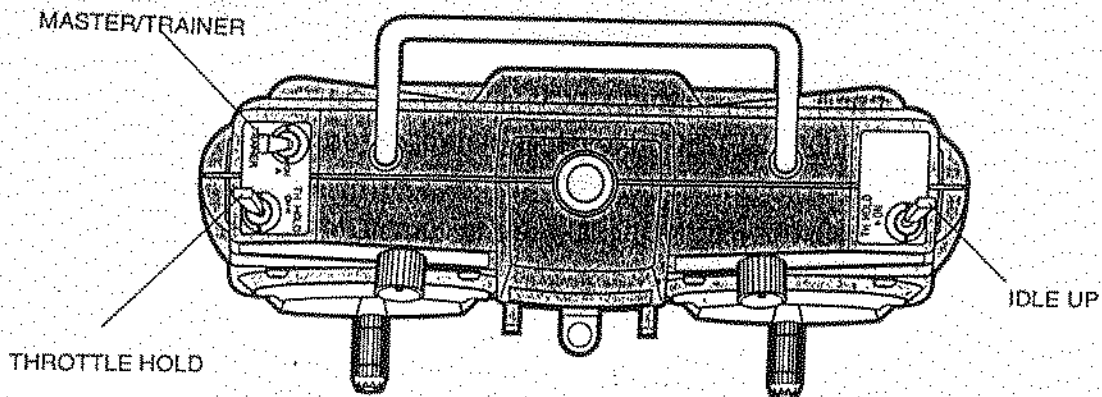

## 20. KEY LOCK

### KEY LOCK PROGRAM

The key lock function is part of the computer program and is displayed on the LCD screen in lieu of the former key lock switch. This function protects the settings you have programmed into the computer so that they cannot inadvertently be changed while flying.

1. Use the FUNCTION SELECT key to set the cursor to the KEY-LOCK position.
2. Press the YES/INC+ key or NO/DEC- key to turn "ON" the function for the selected model PRIOR TO FLYING.
3. The KEY-LOCK should be turned "OFF" whenever you desire to input data or make changes to any setup.

## 21. M-SEL (Model Select)

### M-SEL (Model Select)

This is where you decide which model setup the transmitter will use. Each of the 3 model setups stores the information needed to fly one model. Once you have programmed a setup for a particular model, you may recall that setup at anytime by selecting M1, M2 or M3 using the following procedures:

1. Move the cursor to M-SEL by pushing the FUNCTION SELECT key.
2. Change the model number by pushing either the YES/INC+ key or the NO/DEC- key.

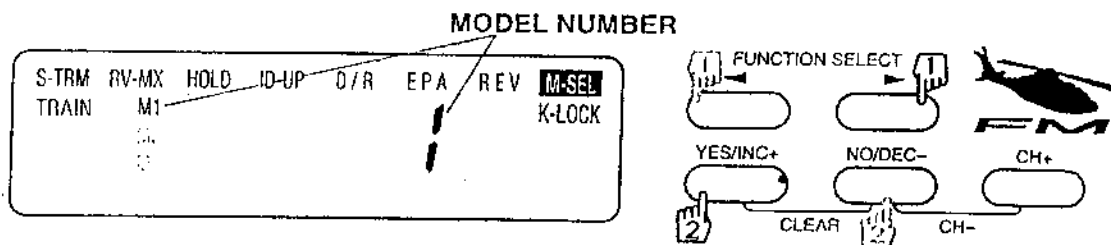

## 22. REV (Servo Reverse)

### REV (Servo Reverse)

In place of the usual reversing switches, the RADIANT system lets you reverse the direction of servo rotation electronically.

Being able to reverse the rotation of the servos lets you install your mechanical control linkages in the most direct and convenient manner and then get the proper direction of control surface movement after the installation is complete. It is accomplished as follows:

1. Move the cursor to the REV position by pushing the FUNCTION SELECT key.
2. Use the CH+ key to select the channel to be set.  
They are:  
CH-1 (throttle), CH-2 (L/R cyclic), CH-3 (F/A cyclic)  
CH-4 (tail rotor), CH-5 (GYRO-activated by idle-up switch)  
CH-6 (collective pitch)
3. Use either the YES/INC+ key or the NO/DEC- key to change the direction of servo movement.

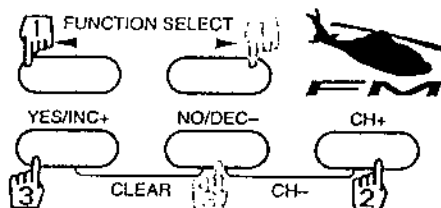
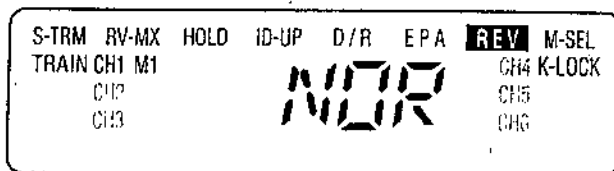

## 23. D/R (Dual Rate)

### D/R (Dual Rate)

The DUAL RATE function allows the user to select either high servo or low servo throw by positioning the IDLE UP switch or THROTTLE HOLD switch (refer to the explanation of switch functions).

The use of low rate on aileron and elevator will generally help in flying smoother maneuvers. This is accomplished by setting low servo throw for hovering, and the models response can be made more sensitive for aerobatics by increasing the servo throw.

1. Use the FUNCTION SELECT key and move the cursor to the D/R position
2. Use the CH+ key to select either CH2 (aileron) or CH3 (elevator) as required.
3. Use the YES/INC+ key or NO/DEC- key to set the amount of dual rate desired.

The adjustment range is 0 to 150%. (The standard value is 100%). When both the IDLE UP and THROTTLE HOLD switches are set to OFF, the DUAL RATE is set to ON. When one of these switches is set to ON, the DUAL RATE function is OFF.

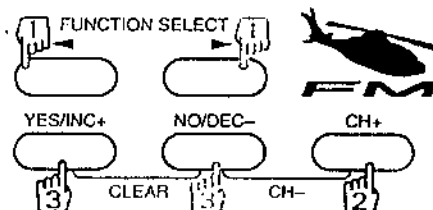
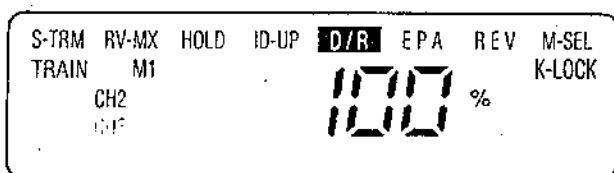

## 24. EPA (End Point Adjust)

### EPA (End Point Adjust)

The maximum servo travel limits (the position the servo assumes when the stick is moved maximum), can be adjusted independently in vertical or horizontal direction for all channels. Use this function, to adjust the servo travel limits as specified in the service manual for your specific helicopter. The adjustment range is 0% to 150%. (The standard value is 100%).

1. Using the FUNCTION SELECT key, move the cursor to the EPA position as noted on the LCD screen.
2. Use the CH+ key to select the channel to be set.  
They are: CH1 (throttle), CH2 (aileron), CH3 (elevator), CH4 (rudder), CH5 (gyro), CH6 (collective pitch).
3. To make an adjustment (for CH1, CH2, CH3, CH4, and CH6), position and hold the stick in the direction desired, then press the YES/INC+ key or NO/DEC- key to obtain the desired servo throw. For CH5, turn off the TH-HOLD switch (left-hand switch), and set the ID-UP switch (right-hand switch) to the direction desired, and press the YES/INC+ key or NO/DEC- key to obtain the value required.

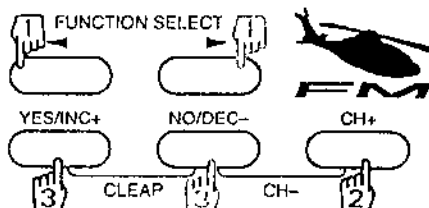
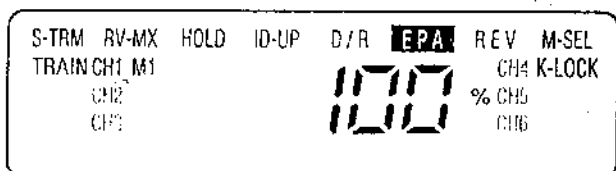

## 25. RV-MX (Revolution Mixing)

### RV-MX (Revolution Mixing)

The Revolution Mixing function is designed to correct the lateral swing of a helicopter's tail as a result of a change of throttle and main rotor pitch control. It is possible to separately set the upward mixing and downward mixing based on the hovering point in the range of -100% to +100%. If a helicopter has a counterclockwise rotating main rotor, a negative (-) setting is applied, and vice-versa for a clockwise rotation. The initial mixing setting is +50%. Therefore, the mixing can be set merely by making a correction while flying the helicopter.

1. Use the FUNCTION SELECT key to move the cursor to the RV-MX position.  
While hovering the helicopter, adjust the rudder trim or tail rotor pitch so as to ensure normal hovering.

#### NOTE:

Do not apply the mixing for this adjustment.

2. Make the helicopter climb from the hovering position. If its nose swings to the left, increase the mixing by setting it to a value higher than +50%. If the nose swings to the right, reduce the mixing by setting it to a value less than +50%. When you want to increase or reduce the mixing while climbing, land your Helicopter and set the Throttle Hold Switch to ON so that the engine does not run too fast.

Then, set the throttle stick to the high throttle position, and use the YES/INC+ key (to increase) or the NO/DEC- key (to reduce) the amount of Revolution mixing.

To set the mixing when the helicopter is descending, use your throttle collective pitch stick to descend from the hovering position. If in this case the nose swings to the right, increase the mixing in the descending flight by setting it to a value higher than 50%. If the nose swings to the left, reduce the mixing in the descending flight by setting it to a value less than 50%. To increase or reduce the mixing while descending, set the throttle stick to the lower position, and use the YES/INC+ key (to increase) or the NO/DEC- key (to reduce) the amount of rev-mixing.

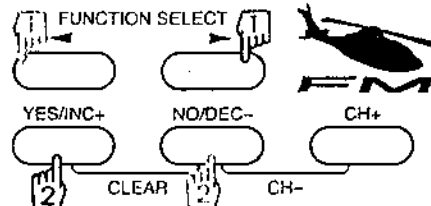
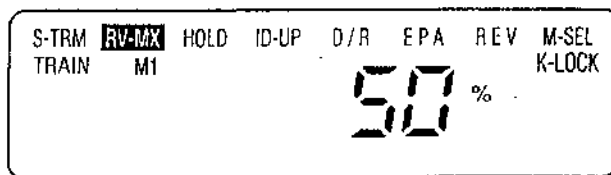



## 26. S-TRM (Sub-Trim)

### S-TRM (Sub-Trim)

The RADIANT 6H incorporates a sub-trim capability. This trim function serves as an auxiliary trim for all channels except for the gyro channel.

It is used for fine adjustment of servo arm centering. The adjustment range is -100% to +100% (max. approx. +10 degrees).

1. To utilize SUB-TRIM, press the FUNCTION SELECT key, and move the cursor indication to the S-TRM position.
2. Using the CH+ key, select the channel which you want to set.
3. Press either the YES/INC+ key or NO/DEC- key, set the servo arm or surface to the neutral position.

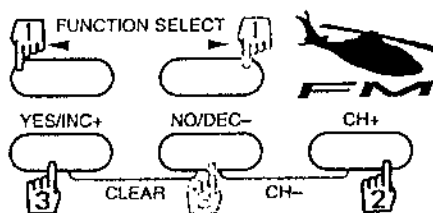
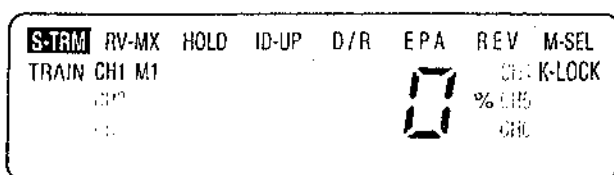

## 27. THROTTLE CURVE

### THROTTLE CURVE

The 3-point throttle curve system is used in the RADIANT 6H. In this system H.N.L. (high, neutral, low) points are operating points.

- Press the FUNCTION SELECT key to set the cursor to the EPA position.
- Use the CH+ key to select CH1 (throttle).
- The setting of H is adjusted by using the H side setting of EPA (end point) CH1 (refer to the explanation of END POINT).
- The N setting is made by using the Hovering Throttle Knob while the IDLE UP switch and THROTTLE HOLD switch are set to OFF (refer to the explanation of Hovering Throttle).
- The L setting is made by using the L side of EPA CH1 or IDLE UP and THROTTLE TRIM (refer to the explanation of END POINT and IDLE UP).

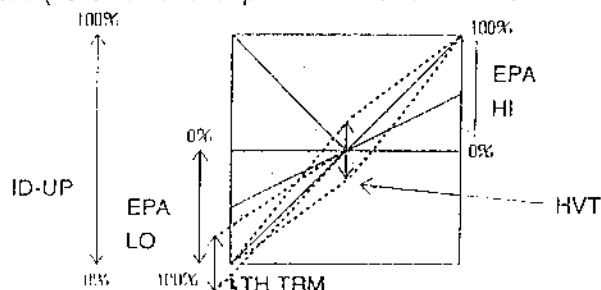

## 28. PITCH CURVE

### PITCH CURVE (EPA on Channel 6, Collective Pitch)

The RADIANT 6H permits you to set 3 different pitch curves, i.e., one normal curve, one Idle-Up curve, and a Throttle-Hold setting when you select EPA/Channel 6 on the LCD screen. This allows you to adjust the pitch curves while your engine is idling.

#### NORMAL PITCH CURVE

1. To set the EPA on each pitch curve use the FUNCTION SELECT key to set the cursor on EPA.
2. Press the CH+ key to select Channel 6.
3. Turn the IDLE-UP and THROTTLE-HOLD switches "OFF", which will allow you to adjust the Low and High EPA for NORMAL Pitch Curve.

#### IDLE-UP PITCH CURVE

1. Proceed as above and then activate the IDLE-UP switch.
2. Adjust the High and Low EPA's for IDLE-UP.

#### THROTTLE-HOLD PITCH CURVE

1. Proceed as above and then activate the THROTTLE-HOLD switch.
2. Adjust the High and Low EPA's for THROTTLE-HOLD.
3. If you desire to return to normal throttle operation, you must turn "OFF" IDLE-UP and the THROTTLE-HOLD switches, and move the Throttle stick to the Low position.
4. Use the FUNCTION-SELECT key to set the cursor to the KEY-LOCK position, and press the YES/INC+ or NO/DEC- key to turn "ON" this function.

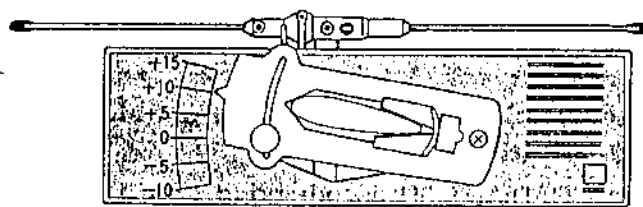
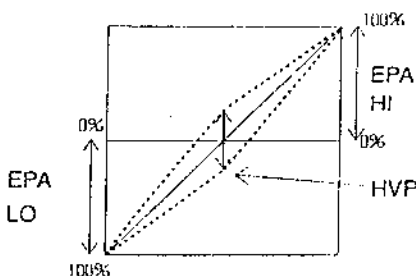

PITCH GAGE

## 29. HOLD (Throttle Hold)

### HOLD (Throttle Hold)

The THROTTLE HOLD function allows autorotation to be performed.

1. Press the FUNCTION SELECT key to set the cursor to the HOLD position.  
Move the Throttle Hold switch to ON.
2. Using the YES/INC+ key or NO/DEC- key, set the engine throttle to obtain a good idle.
  - The switch provided at the upper left side of transmitter is the THROTTLE HOLD switch. When this switch is set to ON, the throttle is fixed in the Throttle Hold position even when the throttle stick is operated.

### NOTE:

Your RADIANT 6H transmitter also allows you to INHIBIT (INH) THROTTLE-HOLD. This allows you to have two Normal Pitch Curves and an IDLE-UP curve. When you activate the THROTTLE-HOLD switch, you will now have a different pitch curve than your Normal Curve. However, you will have the same throttle settings as your Normal Curve. This will allow you to have a Hovering Set-up and also a fly-around set-up with Normal Throttle, and an IDLE-UP for aerobatics.

### CAUTION:

If the Throttle Hold switch is positioned to ON during hovering or while in flight, the throttle is fixed. Therefore, due care must be taken when this switch is used (in the worst case the helicopter may crash).

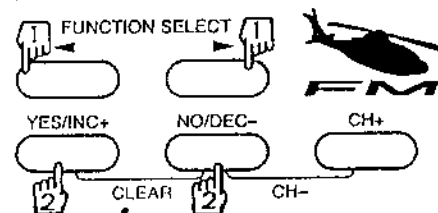
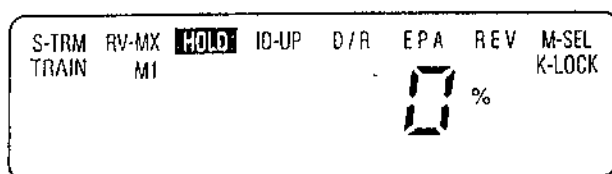

## 30. ID-UP (Idle Up)

### ID-UP (Idle Up)

The RADIANT 6H is equipped with a throttle IDLE-UP function which can be used to maintain the engine speed at a predetermined level while using the main throttle stick to produce low and high pitch conditions. This is desirable to maintain constant Rotor Speed during aerobatic maneuvers.

1. Use the FUNCTION SELECT key to set the CURSOR to the ID-UP position.  
Set the IDLE UP switch to ON.
2. The YES/INC+ key or NO/DEC- key is used to make a setting to obtain the best engine speed best suited to flight when the IDLE UP switch is turned

**CAUTION:**

Before starting the engine, make sure that the IDLE UP switch is OFF!

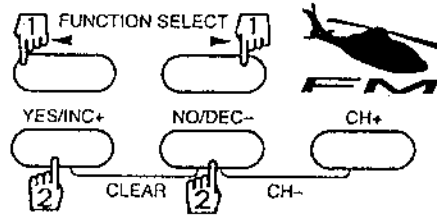
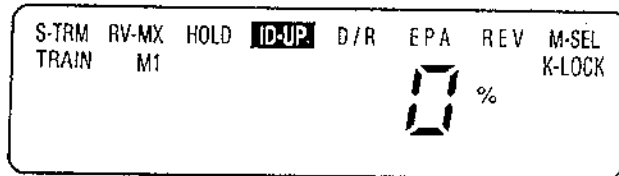

**Functions of Switches**

The IDLE UP switch serves also as a switch to change the sensitivity of the aileron dual rate (D/R), elevator dual rate (D/R), and gyro. Accordingly, when changing from hovering to flying, user can set the flying condition by merely using this switch.

The switch functions are shown in the table below.

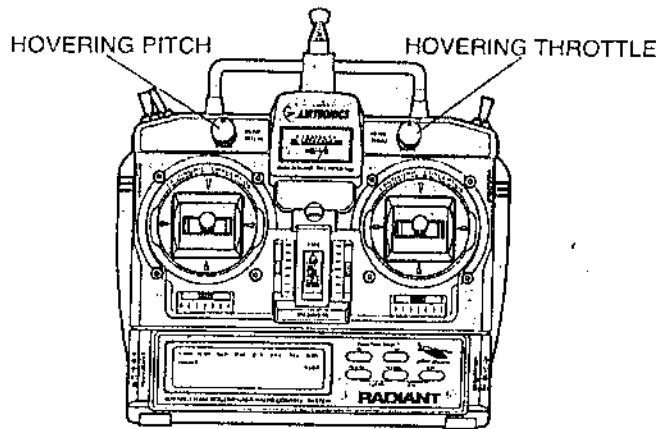

Type of Flying	Switch Position		FLIGHT CONTROL CONDITIONS (Depends on Position of IDLE-UP Switch and THROTTLE-HOLD Switch)						
	ID-UP SW	TH-HOLD SW	ID-UP	TH-HOLD	AI-EL D/R	GYRO	HVT	HVP	TH-TRM
Hovering	OFF	OFF	OFF	OFF	ON	1	ON	ON	ON
Aerobatics	ON	OFF	ON	OFF	OFF	2	OFF	OFF	OFF
Auto Rotation	OFF	ON	OFF	ON	OFF	2	OFF	*OFF	ON
	ON		ON	ON	OFF	2	OFF	*OFF	ON

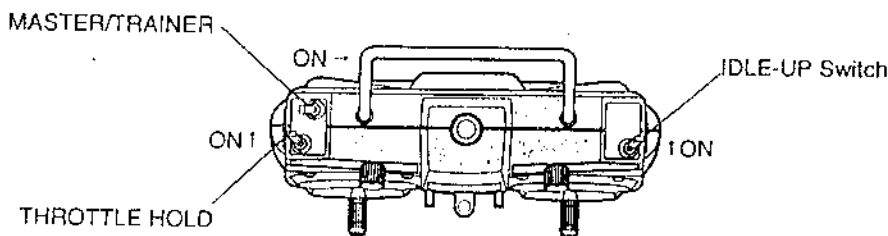

## 31. HVP (Hovering Pitch)

### HVP (Hovering Pitch)

The optimum main rotor pitch while hovering can be obtained by using the knob provided at the front upper left side of transmitter.

#### NOTE:

The HOVERING PITCH is operative **only** when the IDLE UP switch and the THROTTLE HOLD switch are **OFF**.

#### NOTE:

A helicopter's maneuver response varies considerably depending on the rotational speed of the main rotor while hovering.

Generally, the response becomes more sensitive as the rotational speed rises. If the rotational speed is low, the response becomes mild, resulting in poor control action.

The hovering throttle knob and hovering pitch knob are used to adjust the rotational speed of the main rotor when hovering. If the hovering throttle knob is turned clockwise, the rotational speed of main rotor increases. If the hovering throttle knob is turned counterclockwise, the rotational speed of main rotor reduces. If the hovering pitch knob is turned counterclockwise, the rotational speed is increased. Use both knobs to obtain the best hover and response to control inputs.

#### NOTE:

When you set the EPA for the CH6 Pitch Curve, the Throttle automatically becomes Throttle-Hold. Therefore, under this condition, when you change the display from EPA CH6, or when either the Throttle-Hold switch and Idle-Up switch are not in the "OFF" position, or Throttle is not in the low position, a continuous alarm will sound (The reason for the alarm is if your Throttle-Hold is not activated and your Throttle stick is in the high position, the engine will be at high throttle and very dangerous.)

Accordingly, when the Throttle-Hold switch and Idle-Up switch are both "OFF", and the Throttle stick is at low position, the Throttle-Hold is not activated and the alarm will stop sounding.

## 32. HVT (Hovering Throttle)

### HVT (Hovering Throttle)

The optimum position of hovering throttle can be obtained by using the knob provided at the front right upper side of transmitter while hovering your helicopter.

#### NOTE:

The hovering throttle function is operative only when the IDLE UP switch and THROTTLE HOLD switch are OFF.

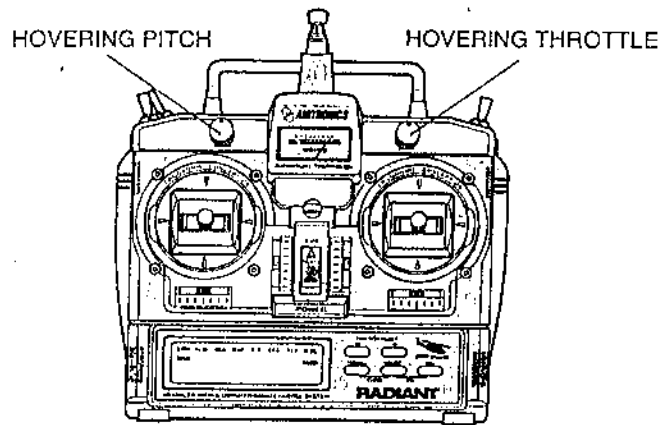

Type of Flying	Switch Position		FLIGHT CONTROL CONDITIONS (Depends on Position of IDLE-UP Switch and THROTTLE-HOLD Switch)						
	ID-UP SW	TH-HOLD SW	ID-UP	TH-HOLD	AI-EL D/R	GYRO	HVT	HVP	TH-TRM
Hovering	OFF	OFF	OFF	OFF	ON	1	ON	ON	ON
Aerobatics	ON		ON	OFF	OFF	2	OFF	OFF	OFF
Auto Rotation	OFF	ON	OFF	ON	OFF	2	OFF	OFF	ON
	ON								

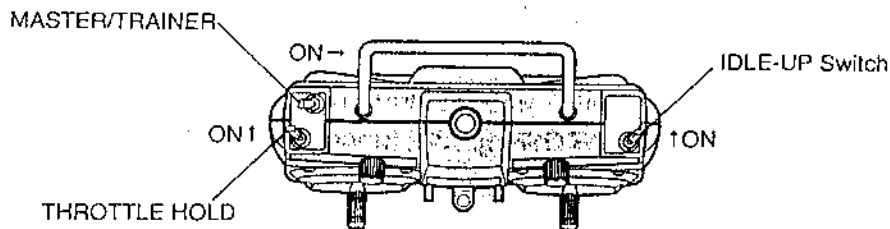

# RADIANT 6P

## 33. TRANSMITTER LAYOUT AND CAPABILITIES

### RADIANT 6P TRANSMITTER CAPABILITIES

#### ELEVATOR-TO-FLAP MIXING

- Aerodynamic lift is increased by using the ELEVATOR-TO-FLAP mixing function. This will enable the model to perform tighter maneuvers such as a square loop.

#### FLAP-TO-ELEVATOR MIXING

- The FLAP-TO-ELEVATOR mixing function allows the elevator to move when the flaps are moved to compensate for pitch changes caused by lowering the flaps. When the flaps are lowered, up or down elevator is applied.

#### AILERON-TO-RUDDER COUPLING

- Coupling of rudder control with operation of the aileron control is provided by the RADIANT 6P transmitter. This results in much smoother turns with some aircraft designs.
- The S-TRM (SUB TRIM) function provides an auxiliary trim for all channels except the landing gear channel.
- The SPOILERON (SPOIRN) function can be used to provide an air braking capability.
- The FLAPERON (FLAPRN) function permits the ailerons to be used as flaps.
- The AILERON DIFFERENTIAL is provided to eliminate unwanted yaw in a model when ailerons are applied.
- The THROTTLE-TO-RUDDER mixing capability can provide correction of nose swing caused by propeller torque when the engine throttle is advanced.
- The THROTTLE-TO-ELEVATOR mixing function will supply an elevator correction when the throttle is advanced or retarded.
- The trainer system permits the expert-level flyer modeler to assist the beginner in learning how to fly.
- DELTA MIX (Elevons) It can be used in a fixed wing model to provide elevon control.
- V-TAIL This menu item allows you to mix the Elevator and Rudder functions together for V-Tailed airplanes. When you move the Elevator Stick both servos will move at the same time in the same direction. When you move the Rudder Stick, the servos will move in opposite directions.

# RADIANT 6P TRANSMITTER LAYOUT

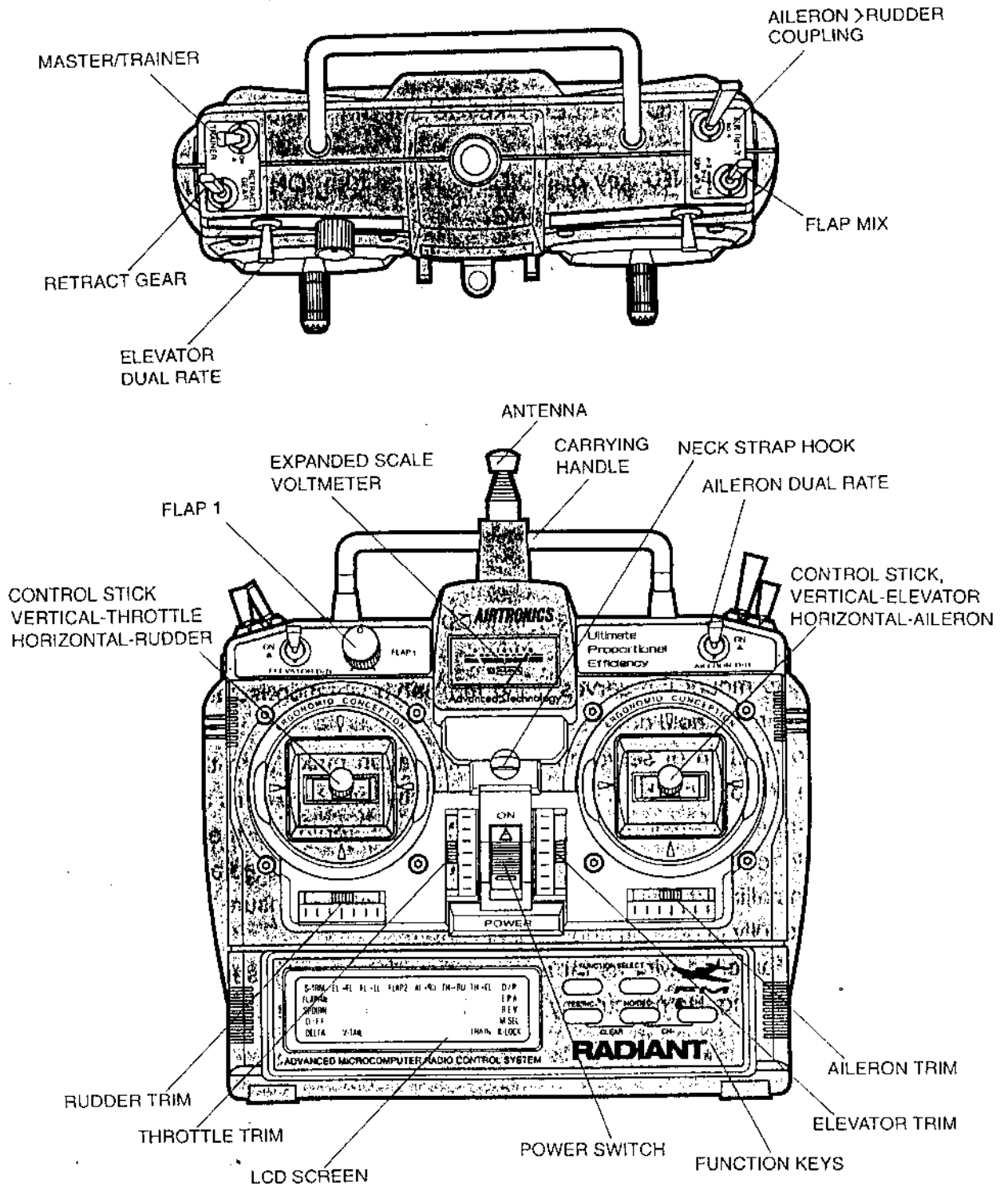



## 34. KEY LOCK

### KEY LOCK PROGRAM

The key lock function is part of the computer program and is displayed on the LCD screen. This function protects the settings you have programmed into the computer so that they cannot inadvertently be changed while flying.

1. Use the FUNCTION SELECT key to set the cursor to the KEY-LOCK position.
2. Press the YES/INC+ key or NO/DEC- key to turn "ON" this function for the selected model PRIOR TO FLYING.
3. The KEY-Lock should be turned "OFF" whenever you desire to input data or make changes to any setup.

## 35. INSTALLATION GUIDANCE

### INSTALLATION GUIDANCE

- Mount the receiver and battery in the plane after wrapping them in at least one half inch of foam rubber.
- Be sure to mount the servos using the Servo vibration isolaters and do not over tighten the hold down screws.
- After completion of servo push rod installation make sure that the servos function smoothly without mutual contact between servo arms and push rods.
- If the servo extensions are used to connect servos to the receiver, it is desirable to prevent their movement by use of double-coated adhesive tape.
- When installing the switch harness on the fuselage, ensure that the switch will move fully in both on and off directions.
- Keep the antenna wire as far away as possible from the servos, metal push rods and wiring. Do not cut any excessive length of antenna wire.

## 36. M-SEL (Model Select)

### M-SEL (Model Select)

This is where you decide which model setup the transmitter will use. Each of the 3 model setups stores the information needed to fly one model. Once you have programmed a setup for a particular model, you may recall that setup at anytime by selecting M1, M2 or M3 using the following procedures:

1. Move the cursor to M-SEL by pushing the FUNCTION SELECT key.
2. Change the model number by pushing either the YES/INC+ Key or the NO/DEC- key.

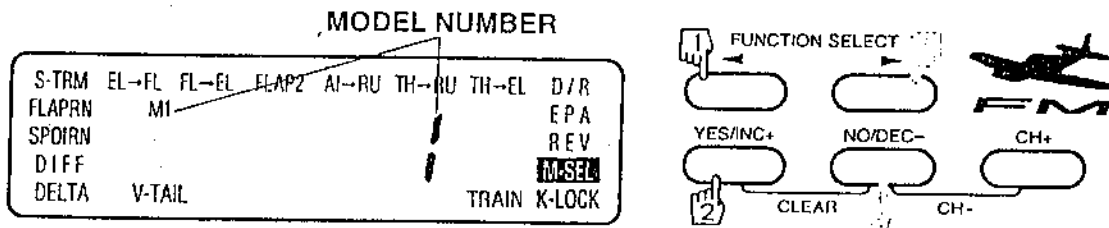

## 37. REV (Servo Reverse)

### REV (Servo Reverse)

In place of the usual reversing switches, the RADIANT system lets you reverse the direction of servo rotation electronically.

Being able to reverse the rotation of the servos lets you install your mechanical control linkages in the most direct and convenient manner and then get the proper direction of control surface movement after the installation is complete. It is accomplished as follows:

1. Move the cursor to the REV position by pushing the FUNCTION SELECT key.
2. Use the CH+ key to select the channel to be set.  
They are:  
CH-1 (throttle), CH-2 (aileron), CH-3 (elevator),  
CH-4 (rudder), CH-5 (gear), CH-6 (flap)
3. Use either the YES/INC+ key or the NO/DEC- key to change the direction of servo movement.

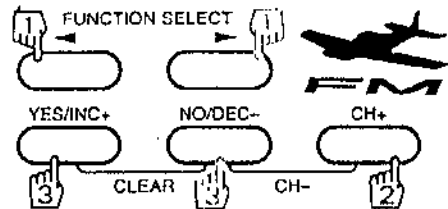
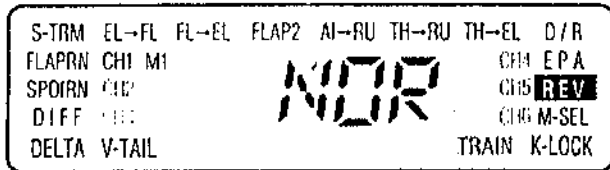

## 38. D/R (Dual Rate)

### D/R (Dual Rate)

The DUAL RATE function allows the user to select either high or low servo throw by positioning the dual rate switches.

1. Use the FUNCTION SELECT key to set the cursor to the D/R position.
2. Use the CH+ key to select either CH2 (aileron) or CH3 (elevator) for which you want to make setting.
3. Turn the specific dual rate switch to the "ON" position, then set the dual rate, using the YES/INC+ key or NO/DEC- key to obtain the amount of servo throw desired.

The adjustment is possible within the range of 0 to 150%. The switch provided at the front left upper side of transmitter is the ELEVATOR DUAL RATE switch. The switch at the upper right side is the AILERON DUAL RATE switch.

### CAUTION:

Always make sure the dual rate switches are in the position you require prior to take-off.

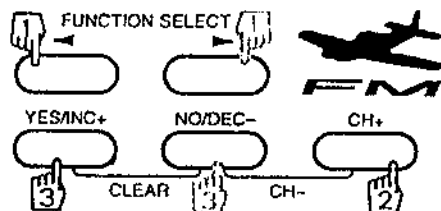
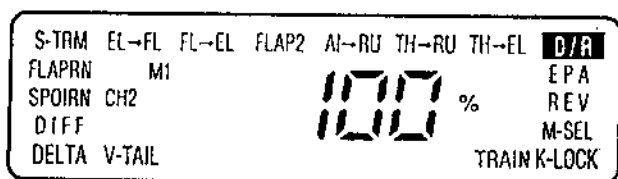

## 39. EPA (End Point Adjust)

### EPA (End Point Adjust)

The END POINT ADJUSTMENTS (EPA) are used to set the maximum servo travel limits. EPA is available on all channels.

The proper EPA value is usually within 80 to 150 percent.

1. Using the FUNCTION SELECT key, set the cursor to the EPA position as noted on the LCD screen.
2. Use the CH+ key to select the channel to be set. They are:  
CH1 (throttle), CH2 (aileron), CH3 (elevator)  
CH4 (rudder), CH5 (gear), CH6 (flap)

3. To make an adjustment, position and hold the control stick in the direction desired (for CH1, CH2, CH3, and CH4), and then press the YES/INC+ key or NO/DEC- key to obtain the desired servo throw.

For CH5, position the gear switch in the direction you wish to set.

For CH6 (flap), turn the flap trim potentiometer located on the upper left front panel in the direction you want to set.

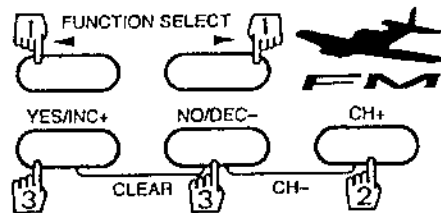
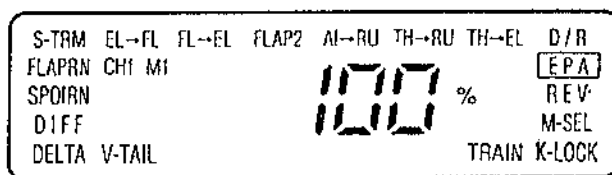

## 40. S-TRM (Sub-Trim)

### S-TRM (Sub-Trim)

The RADIANT 6P incorporates a sub-trim capability. This trim function serves as an auxiliary trim for all channels except for the landing gear channel.

It is used for fine adjustment of servo arm centering. The adjustment range is -100% to +100% (max. approx. +10 degrees).

1. To utilize SUB-TRIM, press the FUNCTION SELECT key, and move the cursor indication to the S-TRM position.
2. Using the CH+ key, select the channel which you want to set.
3. Press either the YES/INC+ key or NO/DEC- key, set the servo arm or surface to the neutral position.

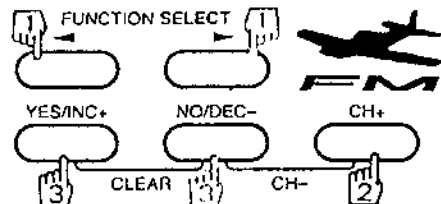
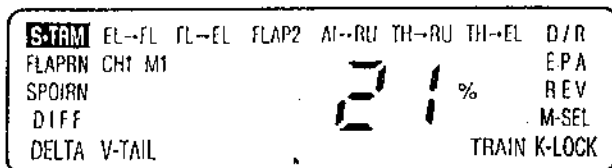

## 41. AI → RU (Aileron-to-Rudder Coupling)

### AILERON TO RUDDER COUPLING SWITCH

A switch is now provided, on the upper right side of the transmitter, to give you the ability to turn this function ON and OFF.

1. Use the FUNCTION SELECT key to set the cursor to the AL-RU position.
2. Press the YES/INC+ key or NO/DEC- key to obtain the amount of coupling desired.
3. Turn the AL-RU switch to the "ON" position.
4. You can modify the setting after flying to obtain the degree of coupling that provides a smooth turn.

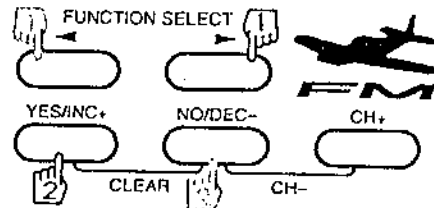
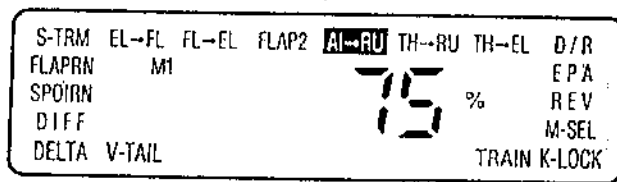

## 42. SPOIRN (Spoileron)

### SPOIRN (Spoileron)

The SPOIRN is a function to provide an air brake capability when landing. It is accomplished by simultaneously raising the left and right ailerons. If the deflection angle is low, it will give an effect similar to wash-out in the wing, so that tip stall is delayed and the landing speed is reduced.

If you want to use the SPOIRN function, you must use separate servos for both the left and right ailerons. These will be plugged into channels 2 and 6 of the receiver.

1. Use the FUNCTION SELECT key to set the cursor to the SPOIRN position.
2. Press the YES/INC+ key or NO/DEC-key to turn "ON" this function. The throttle stick will now control the amount the ailerons deploy upward.

### NOTE:

If this function is not required, turn the SPOIRN function "OFF".

If the throttle stick is moved downward, the left and right ailerons are raised, giving an air brake effect, i.e., crow configuration. This function is normally only used for a sailplane.

**NOTE:**

Throttle Trim only works at high throttle position when Spoilerons are on.  
The FLAPERON (FLAPRN) function is normally used for engine powered models.

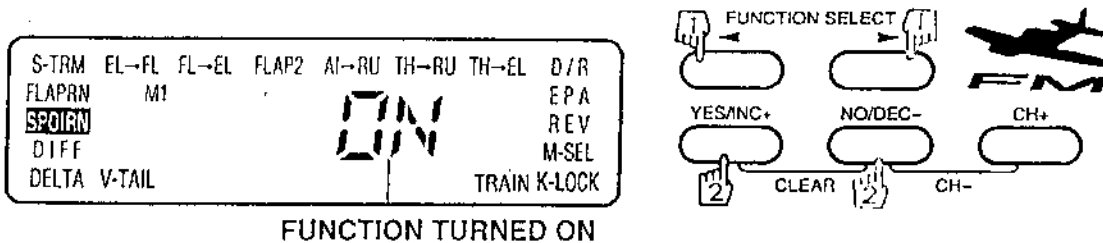

## 43. FLAPRN (Flaperon)

### FLAPRN (Flaperon)

This function allows the strip ailerons on a full-aileron plane to act as a flap. If you want to use the FLAPRN function, you must use separate servos for both the left and right ailerons. These will be plugged into channels 2 and 6 of the receiver.

1. Use the FUNCTION SELECT key to set the CURSOR to the FLAPRN position.
2. Press the YES/INC+ key or NO/DEC- key to turn "ON" this function. The left and right strip ailerons can now be used as flaps by using the FLAP switch or by the FLAP 1 trim potentiometer when the FLAP switch is in the middle position.

**NOTE:**

If the FLAP function is used, very tight maneuvers can be accomplished if you also use the FLAP-TO-ELEVATOR mixing capability.

In addition, if a spoileron type effect is desired for an engine powered plane, it can be obtained by inverting the operating direction of the flaps.

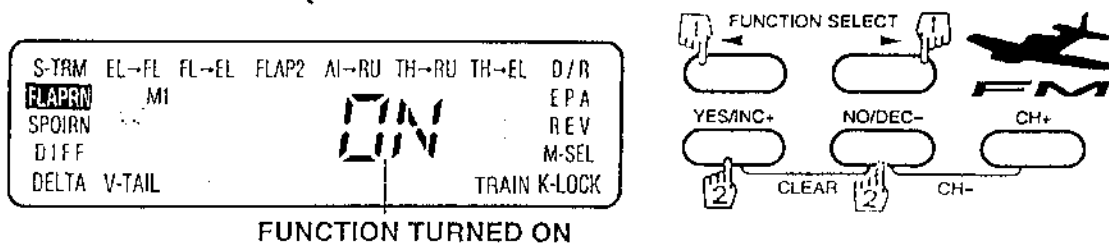

## 44. DIFF (Differential Ailerons)

### DIFF (Differential Ailerons)

When the ailerons are operated during flying, the air resistance of the aileron that is lowered becomes higher than the air resistance on the aileron that is raised so that the nose swings in the direction opposite to the turning direction, i.e., unwanted yaw. To reduce the influence of this phenomenon, the amount of aileron that is lowered is reduced and the amount of up aileron is increased. This is called "giving differential deflection to the ailerons". If you want to use the aileron differential function, you must use separate servos for both the left and right ailerons.

1. First use the FUNCTION SELECT KEY to set the cursor to FLAPRN position on the LCD screen to obtain the output for two aileron servos.
2. If actual FLAPERON operation is not desired, move the cursor to FLAP 2 and set the FLAP 2 to zero. Then, turn the FLAP 1 TRIMMER fully counterclockwise. This will prevent any inadvertent operation of the flap switch from operating flaperons.
3. Next use the FUNCTION SELECT key to set the cursor to the DIFF position.
4. Use the YES/INC+ key or NO/DEC- key to set the deflection angle of the aileron that goes down to about 1/2 of aileron that goes up. The value can either be negative or positive.

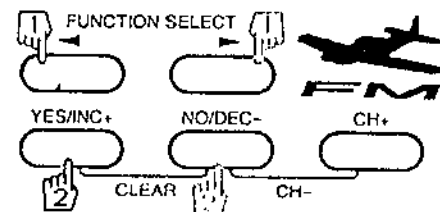
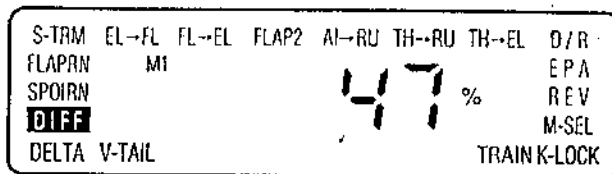

## 45. FLAP 1

### FLAP 1

Flaps are designed to increase the aerodynamic lift. It is effectively used when lift is required for low speed when landing.

1. The FLAP 1 function is activated when the FLAP switch provided at the right upper side of transmitter is set to the center position, and the FLAP 1 TRIMMER provided at the front side of transmitter is turned.



- It is possible to obtain 3 positions for flaps by changing the flap angle in 2 stages with the aid of the FLAP switch. If the FLAP switch is set in the E → F position, the flap is kept raised. If the FLAP switch is set in the center of F1 → E position, the flap is set to half flaps. The angle of the flaps is set at this point with the trimmer of FLAP 1. If the FLAP switch is set to the F2 → E position, The flap is set to full flaps. The flap deflection angle is set using FLAP 2 on the LCD panel. It is variable from 0 to 100%.

**NOTE:**

Refer to the explanation of FLAP 2.

## 46. FLAP 2

### FLAP 2

The FLAP 2 function can be actuated by using the FLAP switch provided at the right upper side of transmitter. If it is used in combination with the FLAP 1 (flap trimmer on the front panel of transmitter), it can be used for setting the second position of the flaps when operated by the FLAP switch.

- Use the FUNCTION SELECT key to set the cursor to the FLAP 2 position.
- Use the YES/INC+ key or NO/DEC- key to set the angle of the flaps higher than the FLAP 1 angle.

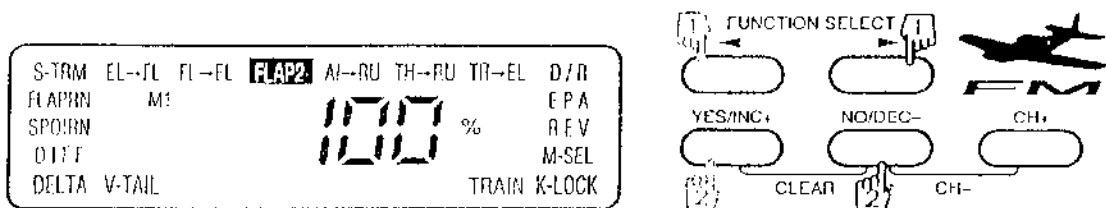

## 47. EL → FL (Elevator-to-Flap Mixing)

### EL → FL (Elevator-to-Flap Mixing)

With this function you can cause the flaps to move whenever the elevator stick is moved. This function is most commonly used for aerobatic models, where deploying flaps with elevator control can make for tighter corners on maneuvers such as the square loop. With up elevator the flap should go down.

1. Use the FUNCTION SELECT key to set the cursor to the EL → FL position.
2. Use the YES/INC+ key to set the mixing rate. To reduce the mixing rate, press the NO/DEC- key.
3. If desired, adjust FLAP 1 knob to get required FLAP position.

**NOTE:**

To use this function, set the FLAP MIX switch provided at the right upper side of transmitter to the E → F position.

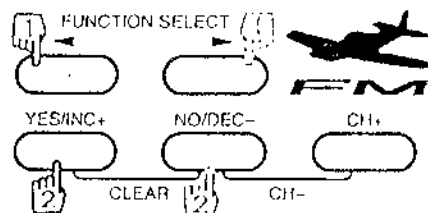
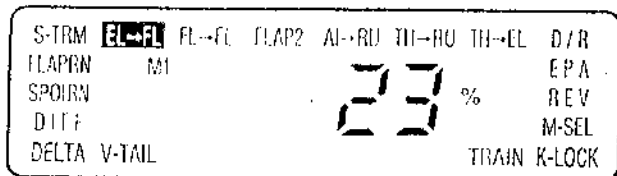

## 48. FL → EL (Flap-to-Elevator Mixing)

### FL → EL (Flap-to-Elevator Mixing)

When flaps are lowered, the lift increases. Therefore, the RADIANT 6P transmitter provides FLAP-ELEVATOR mixing which allows the elevator servo to move to a pre-set position whenever flaps are lowered, thus compensating for any pitch changes induced by the flaps.

1. Use the FUNCTION SELECT key to set the cursor to the FL → EL position.
2. Use the YES/INC+ key or NO/DEC- key to set the mixing in the proper direction to achieve a small amount of down elevator when the flaps are activated.

**NOTE:**

Flight testing will be required to find the optimum amount of FLAP-ELEVATOR mix.

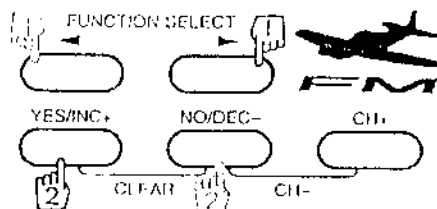
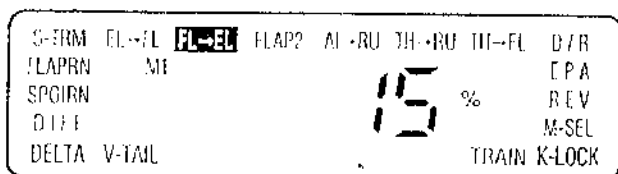

## 49. TH→RU (Throttle-to-Rudder Mixing)

### TH→RU (Throttle-to-Rudder Mixing)

In an engine or motor powered model, torque caused by propeller rotation normally tries to swing the nose of the model to the left.

Therefore, THROTTLE-TO-RUDDER mixing is used to reduce this phenomenon. When the throttle is advanced to the HIGH position, the rudder can act in the correct direction so that the nose swing caused by torque is corrected.

1. Use the FUNCTION SELECT key to set the cursor to the TH→RU position.
2. Use the YES/INC+ key or NO/DEC- key to set the amount of mixing.

#### NOTE:

Flight testing will be required to fine tune the setting.

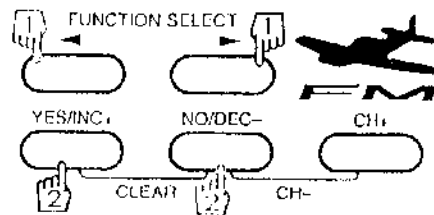
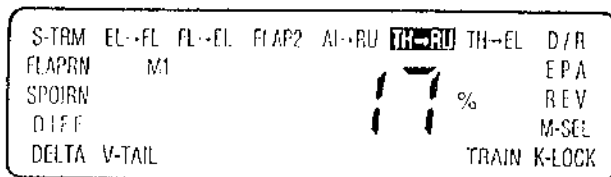

## 50. TH→EL (Throttle-to-Elevator Mixing)

### TH→EL (Throttle-to-Elevator Mixing)

When an engine or motor powered model is climbing at full throttle, an abnormal nose-up attitude may occur. In this case, the abnormal nose-up attitude can be corrected by applying the THROTTLE-TO-ELEVATOR mixing.

#### NOTE:

This function is valid only when engine or motor speed is controlled by using the throttle stick.

1. Use the FUNCTION SELECT key to set the cursor to the TH→EL position.
2. Use the YES/INC+ key or NO/DEC- key to set the mixing so that a small amount of down elevator is set in when the throttle stick is moved from LOW to HIGH.

**NOTE:**

Flight testing will be required to find the optimum amount of THROTTLE-TO-ELEVATOR mixing.

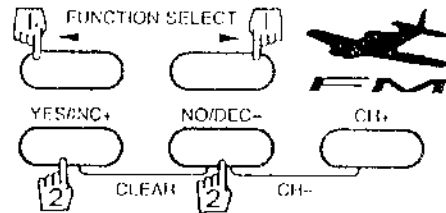
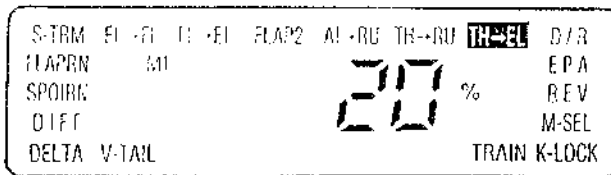

## 51. DELTA MIX (Elevons)

### DELTA MIX (Elevons)

It can be used in a fixed wing model to provide elevon control.

1. To utilize this function, press the FUNCTION SELECT key, and move the cursor to the DELTA position.
2. Press either the YES/INC+ key or the NO/DEC- key to turn "ON" this function.
3. Servos should be plugged into channels 2 and 3 of the receiver for elevons, i.e., Elevator/Aileron control.

## 52. V-TAIL

### V-TAIL

This menu item allows you to mix the Elevator and Rudder functions together for V-Tailed airplanes. When you move the Elevator Stick both servos will move at the same time in the same direction. When you move the Rudder Stick, The servos will move in opposite directions.

1. To utilize this function, press the FUNCTION SELECT key, and move the cursor to the V-TAIL position.
2. Press either the YES/INC+ key or the NO/DEC- key to turn "ON" this function.
3. Servos should be plugged in to channels 3 and 4 of the receiver for V-Tail control.