



# AIRTRONICS®

## **RD6000 Sport**

Radio System  
Operating Manual



**Airplane • Helicopter • Sailplane**

***This equipment has been tested in accordance with the requirements contained in the appropriate Commission regulations. To the best of our knowledge, these tests were performed using measurement procedures consistent with industry or Commission standards and demonstrate that the equipment complies with the appropriate standards. Each unit manufactured, imported or marketed, as defined in the Commission's regulations, will conform to the sample(s) tested within the variations that can be expected due to quality production and testing on a statistical basis. We further certify that the necessary measurements were made by Kansai Electronic Industry Development Center, Ikoma Emission Measurement Station, 10830, Takayama-Cho, Ikoma-City, Nara, 630-01 Japan.***

# TABLE OF CONTENTS

<b>Page #</b>	<b>SECTION I INTRODUCTION</b>
4	RD6000 Sport Radio Control System
4	RD6000 Sport Transmitter/Receiver Specifications
5	Academy of Model Aeronautics
5	Initial Preparation
6	NiCd Battery Charging
6	RD6000 Sport Transmitter Features
7	Airborne System Connections
8	Airborne Components
8	Connectors
8	Audio Low Voltage Alarm
9	Transmitter Battery Removal
9	Control Stick Length Adjustment
9	Throttle High Warning
10	Transmitter Stick Tension Adjustment
11	Trainer System
12	Using the RD6000 Sport Micro-Processor
13	Aero Features Description
14	Heli Features Description

## **SECTION II COMMON FUNCTIONS**

15	Implementation of Control Function
15	Servo Reversing
16	Control Centering
17	Data Reset
18	Model Selection
19	Stop Watch
20	Integral Timer
21	Model Naming
22	Exponential
24	Modulation
25	Data Copy
27	Switch Reverse
28	Click
29	Throttle Cut

## **SECTION III**

30	RD6000 Sport Users Manual- Aircraft
31	Aircraft Menu Structure
32	Programming for Aircraft (Model Type)
34	Dual Rate
35	End Point Adjustments
36	Landing Gear End Points
37	Trim Memory
38	Flaperons
40	Alarms
41	Delta (Elevons)
42	Aileron to Rudder Mix
43	V-Tail (Rudder to Elevator Mix)
44	Throttle to Elevator Mix
58	Compensation Mixers (C-Mix) <i>AIRCRAFT ONLY</i>

## **SECTION IV HELICOPTER**

### **Page #**

45	RD6000 Sport User Manual - Helicopter
7	Airborne System Connections
46	Helicopter Menu Structure
47	Programming for Helicopter (Type)
49	Pitch Curves
52	Throttle Curves
54	Revolution Mixing
55	Gyro Adjustment
56	Trim Memory
22	Exponential
56	Dual Rate
57	Dynamic Trim Memory (DTM)
60	Changing Flight Mode 1 and 2 Switch Locations

## **APPEND I**

RD6000 Sport Aircraft and Helicopter Setup pages

## **SECTION I**

### **RD6000 SPORT RADIO CONTROL SYSTEM**

*Thank you for selecting the Airtronics RD6000 Sport Radio System. In designing the RD6000 Sport we have made every effort to provide you with a radio that will allow you to extract the maximum performance from your powered aircraft, sailplane, or helicopter, while at the same time simplifying the task of setting up and adjusting your model. These instructions are written in great detail to help you understand what all of your RD6000 Sport capabilities are. Because of the many features of the RD6000 Sport, this manual is quite long. Don't be intimidated! To actually use the system, you may only need to read the INTRODUCTION section, the Common Functions section, and study the section that applies to your type of aircraft. Each type of aircraft, i.e., fixed wing and helicopter has its own self-contained section describing each applicable feature and its implementation. However, helicopter flyers may find it advantageous to read all sections of the manual to become more acquainted with the operation of the RD6000 Sport unit. Note that the labels for fixed wing switch functions are in red letters and helicopter switch functions are in white letters.*

*Again, we appreciate your selection of an Airtronics Radio Control System and wish you many hours of flying enjoyment.*

#### **RD6000 Transmitter Specifications:**

Transmitter Type:	6 Channel, Dual Stick with propriety Microprocessor.
Dimensions:	W: 7.5" X H: 8.0" X D: 2.5"
Weight:	1 lb. 11 oz
Power Output:	600 mWatts
Frequencies:	72 MHz
Modulation:	PPM/FM or PPM/FM Reverse
Power Supply:	9.6 Volt, 700 mAh NiCd
Current Drain:	180 MA
Temperature Range:	0 to 160 degrees F
Pulse Width:	1.5 ms (nominal)
Model Memory:	4

#### **RD6000 Sport Receiver Specifications:**

Receiver Type:	92777Z PPM/FM 7 Channel, Super Narrow Band with Universal "Z" Connectors
Receiver Sensitivity:	1.5 microvolts
Dimensions:	L: 2.25", W: 0.6", H: 0.82"
Weight:	1.2 ounces
Receiver Power Supply:	Four Cell, 4.8 Volt, 700 mAh NiCd

*The following additional receivers are compatible if part number 99399Z Adaptor is used.*

92745 PPM/FM 4 Channel, Micro Super Narrow Band Receiver  
92765 PPM/FM 6 Channel, Super Narrow Band Receiver

ACADEMY OF MODEL AERONAUTICS  
5151 East Memorial Drive  
Muncie, Indiana 47302

The Academy of Model Aeronautics (AMA) is a national organization representing modelers in the United States. We urge you to examine the benefits of membership, including liability protection in the event of certain injuries. The Academy has adopted simple and sane rules which are especially pertinent for radio controlled flight as the OFFICIAL AMA NATIONAL MODEL AIRCRAFT SAFETY CODE, which we have partially reprinted below:

I will not fly my model aircraft in sanctioned events, airshows or model flying demonstrations until it has been proven to be airworthy by having been previously, successfully flight tested.

I will not fly my model higher than approximately 400 feet within 3 miles of an airport without notifying the airport operator. I will give the right-of-way and avoid flying in the proximity of full-scale aircraft. Where necessary, an observer shall be utilized to supervise flying to avoid having models fly in the proximity of full-scale aircraft.

Where established, I will abide by the safety rules for the flying site I use, and I will not willfully and deliberately fly my models in a careless, reckless and/or dangerous manner.

I will have completed a successful radio equipment ground range check before the first flight of a new or repaired model.

I will not fly my model aircraft in the presence of spectators until I become a qualified flyer, unless assisted by and experienced helper.

I will perform my initial turn after take off away from the pit or spectator areas, unless beyond my control.

I will operate my model using only radio control frequencies currently allowed by the Federal Communications Commission. (See chart below) Only properly licensed amateurs are authorized to operate equipment on amateur band frequencies.

**72 MHz BAND by Channel and Channel Frequency**

11 72.010	21 72.210	31 72.410	41 72.610	51 72.810
12 72.030	22 72.230	32 72.430	42 72.630	52 72.830
13 72.050	23 72.250	33 72.450	43 72.650	53 72.850
14 72.070	24 72.270	34 72.470	44 72.670	54 72.870
15 72.090	25 72.290	35 72.490	45 72.690	55 72.890
16 72.110	26 72.310	36 72.510	46 72.710	56 72.910
17 72.130	27 72.330	37 72.530	47 72.730	57 72.930
18 72.150	28 72.350	38 72.550	48 72.750	58 72.950
19 72.170	29 72.370	39 72.570	49 72.770	59 72.970
20 72.190	30 72.390	40 72.590	50 72.790	60 72.990

**INITIAL PREPARATION**

**PACKAGING:**

The packaging of your Airtronics RD6000 Sport Radio Control System has been especially designed for the safe transportation and storage of the radio's components. After unpacking your radio, DO NOT DISCARD THE CONTAINERS! You should set the packaging aside for use if you ever need to send your radio in for service, or to store your radio in case you do not plan to use it for an extended period of time.

### **NiCd BATTERY CHARGING INFORMATION:**

In order to protect the charging circuit in your RD6000 Sport transmitter, a diode has been installed to protect it from some of the high discharge rate "cyclers" on the market. We recommend that you charge the transmitter battery (while installed) with the supplied ATX charger, Part # 95033. Should you wish to "cycle" or discharge the transmitter battery, you must first remove it from the transmitter. This allows you to bypass the protective diode. The following two Airtronics service items will allow you to "cycle" your RD6000 Sport transmitter battery. See your local dealer for these items.

(1) #99704 Transmitter Charging Plug with Cable for use with your cycling device (black wire w/white tracer is positive).

(1) #97051 Transmitter Battery Cycling Adapter Cable.

Above items will also work with Airtronics Quasar, Radiant, and Vanguard transmitter batteries. Airtronics does NOT recommend the use of any fast or quick chargers.

### **RD6000 SPORT TRANSMITTERS FEATURES**

The RD6000 Sport narrow band PPM/FM computer radio control system is designed for the use by power model, sailplane, and helicopter pilots who demand a quality product. The RD6000 Sport is packed with all of the capabilities that the beginner as well as the more advanced modelers demand for all three types of flying. It has the features available to get the most out of any type of model.

#### ***Program Features for all types of models***

4 Model Memory  
Stop Watch  
Digital Trims  
Servo Reversing on all channels  
Dual Rate on Elevator and Aileron channels  
(Plus Rudder on Helicopter)  
Large Screen Liquid Display (LCD)  
End Point Adjustment on all channels

Model Type selection  
Center Adjustment on EL, AL, TH, RU, and P-F  
Data Reset  
LCD Transmitter Voltage Meter  
High Capacity Transmitter/Receiver NiCd Batteries  
Adjustable Stick Tension and Length  
Low Battery, High Throttle and Power Alarms

# AIRBORNE SYSTEM CONNECTIONS

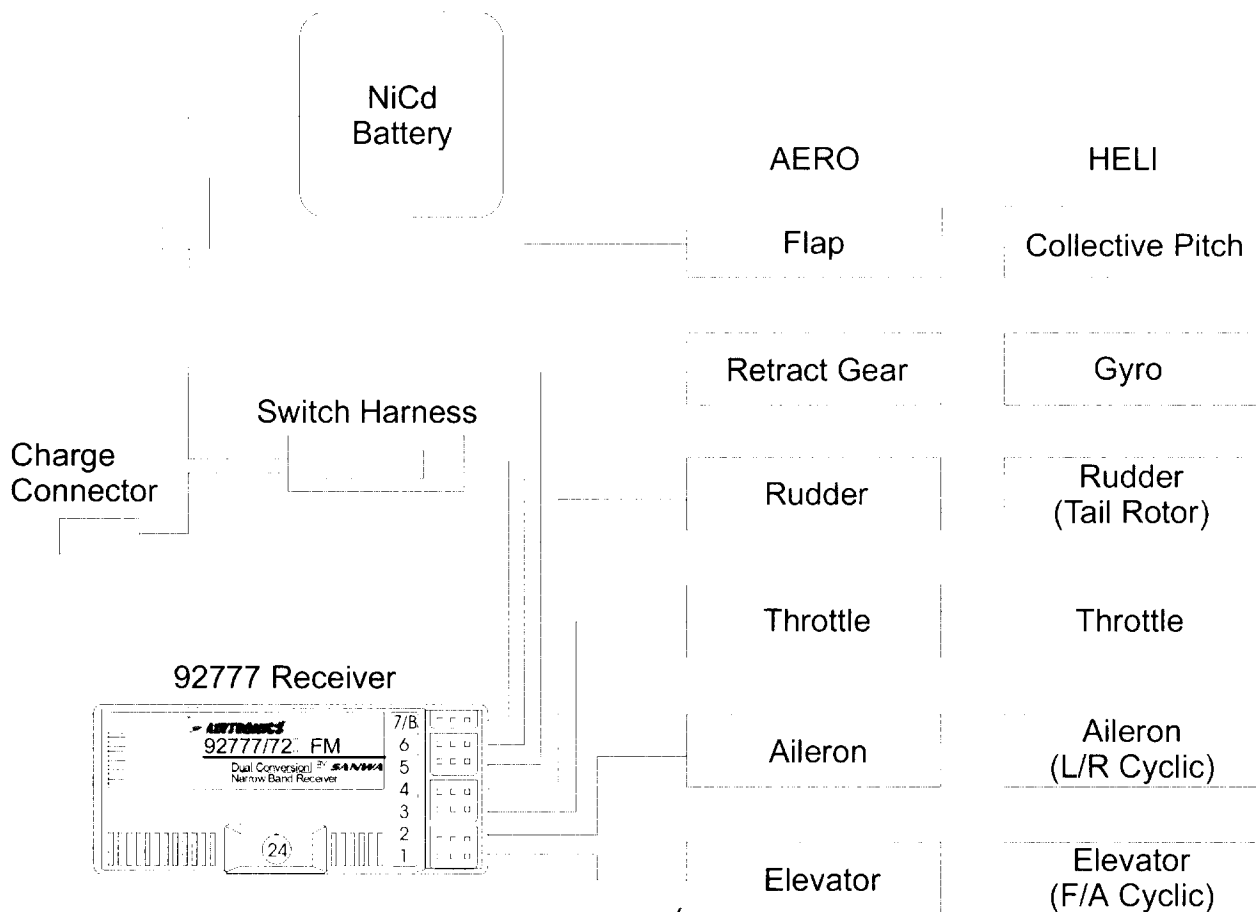

The above diagram shows how to connect the components of your RD6000 Sport system together. At this point your objective is to get the system operating on your workbench. Once connected you must then refer to the corresponding diagram for your system, i.e., either AERO or HELI showing the transmitter control stick function.



## **AIRBORNE COMPONENTS**

While your systems batteries are charging, you can familiarize yourself with the airborne portion of your radio. The airborne portion of the radio refers to any components which are mounted in your plane or helicopter and carried aloft when you fly. The airborne components consist of the receiver, which receives the signals from the transmitter, decodes them, and relays the commands to the servos; the servos which are simply electronically controlled motors used to move the controls of the plane; the NiCd battery pack which provides power for the receiver and servos to operate; and the switch harness which allows you to turn the airborne package on and off.

## **CONNECTORS**

Your RD6000 Sport unit is equipped the new universal AIRTRONICS "Z" connectors which are color coded blue, and are electrically compatible with the receivers of other radio control system manufacturers. The connectors are rugged but should be handled with care. Note that these connectors are not compatible with older AIRTRONICS R/C equipment unless Adapter p/n 99399Z is used!

### **"Z" CONNECTOR**

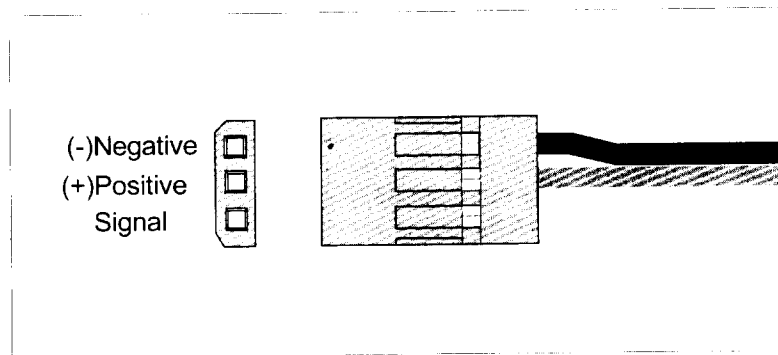

### **AUDIO LOW VOLTAGE ALARM**

Your RD6000 Sport transmitter is equipped with an Audio Alarm which will sound whenever the transmitter batteries drop below 9.5 volts during transmitter operation. If the alarm sounds while you are flying, land immediately and don't operate the transmitter until it has been charged for 12 hours. The transmitter should normally operate 120 to 150 minutes before the alarm sounds. If the alarm sounds even after the batteries have been on charge for the required time it indicates that there is a problem with either the battery pack or the transmitter, and you should contact AIRTRONICS about service.

## **TRANSMITTER BATTERY REMOVAL**

The NiCd battery in your RD6000 Sport transmitter can easily be removed and replaced with a fully charged pack to extend operating time. Additional packs are sold separately as an accessory item under the Airtronics part number 95010. To remove the pack, push down on the two ears of the battery door located on the rear of the transmitter. The door can then be removed and the NiCd battery pack can now be removed and unplugged. Reverse the procedure to install a new pack.

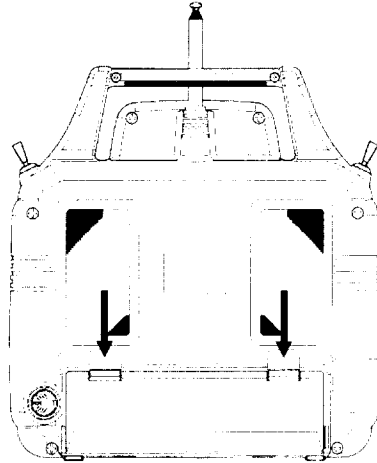

### **CAUTION:**

Observe the correct polarity when plugging in the NiCd battery pack. If incorrect, damage to the transmitter will occur!

## **CONTROL STICK LENGTH ADJUSTMENT**

The sticks in your RD6000 Sport transmitter are adjustable in length and spring tension to allow you to tailor their feel to your personal preference. To adjust stick length, hold Part B with your fingers and unscrew Part A counterclockwise to loosen the two pieces. Now screw Part A in or out to the desired position and lock it in place by screwing Part B against it. It is best to leave at least four threads inside Part A when screwed out to its longest length for the best mechanical security. Do not over tighten when you screw the two parts together.

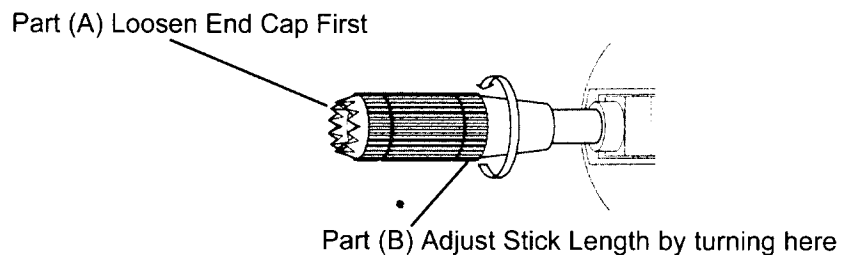

## **THROTTLE HIGH WARNING**

The RD6000 Sport has a built in warning feature that will not allow you to use the transmitter if the throttle stick is not in the lowest position when you turn on the transmitter. If the throttle stick is not in the low position, when you turn it on, you will hear a continuous beeping sound and the display will read TH-HI! Pull the throttle stick down to the full low position. The normal menu will then be displayed and you can operate and/or program the transmitter.

## TRANSMITTER STICK TENSION ADJUSTMENT

To adjust the spring tension of the transmitter sticks you need to remove the back of the transmitter case. First remove the antenna and the NiCd battery pack from the transmitter. Now remove the eight screws that hold the case back in place, four in the main case, two in the LCD back cover and two on the handle. Once the screws are removed swing the back of the case away from the transmitter being careful of the trainer plug wiring.

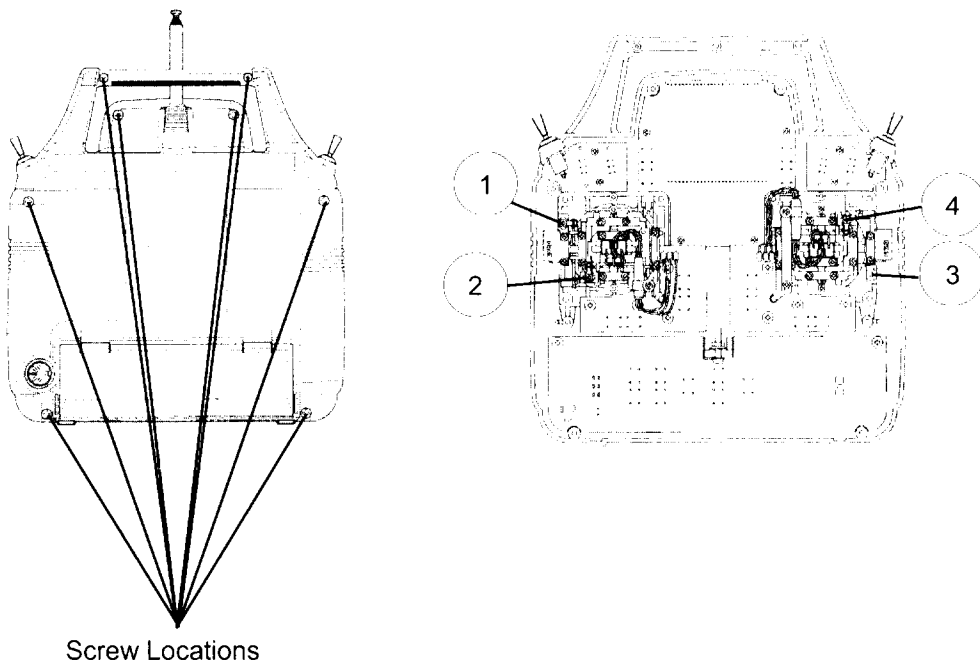

Screw Locations

There are four locations for the stick tension adjustment screws installed because the stick controlling the throttle is reattached and has no tension adjustment. The #1 and #3 screws adjust the tension for the vertical motion of each stick. The #2 and #4 screws adjust the tension for the horizontal motion of each stick. To make the tension adjustment use a small phillips type screwdriver to turn the adjustment screws. Turning the screw clockwise will increase the stick tension, turning it counterclockwise will decrease the tension. Once you have completed your stick adjustments, replace the case back and install the NiCd battery pack and antenna. Be careful to line the battery charging port pins when replacing the back cover.

### WARNING:

Any other modifications made to the transmitter other than adjusting stick tension will void any and all warranties covered by Airtronics Inc.

## TRAINER SYSTEM

The Trainer system in the RD6000 Sport transmitter allows you to connect any two Airtronics RD6000 Sport together for the purpose of training a new pilot. You can also connect the RD6000 Sport to either an RD6000 Super, RD6000, VG 400, VG 600, Radiant or Vanguard PPM unit. The Trainer cord to use is the ATX Part # 97100. **The RD6000 Sport is NOT compatible with Infinity 660 or Quasar units.**

In actual use, one of the two transmitters will serve as the Master and the second transmitter will serve as the Trainer. The Master transmitter is held by the instructing pilot, AND IS THE TRANSMITTER THAT MUST MATCH THE RECEIVER FREQUENCY INSTALLED IN THE MODEL! The trainer transmitter is held by the learning pilot, and does not need to be on the same frequency as the model. The frequency of the Trainer transmitter is unimportant because the switch of the trainer transmitter is NOT turned on during instructional flying. Normally during training, the instructor takes the model off and flies it to a reasonable altitude. While the Master/Trainer switch on the Instructors transmitter is left in its OFF position, the Master transmitter will have full control of the model. When the instructor is ready to begin training, he presses and holds the spring loaded switch on his transmitter which transfers control to the student.

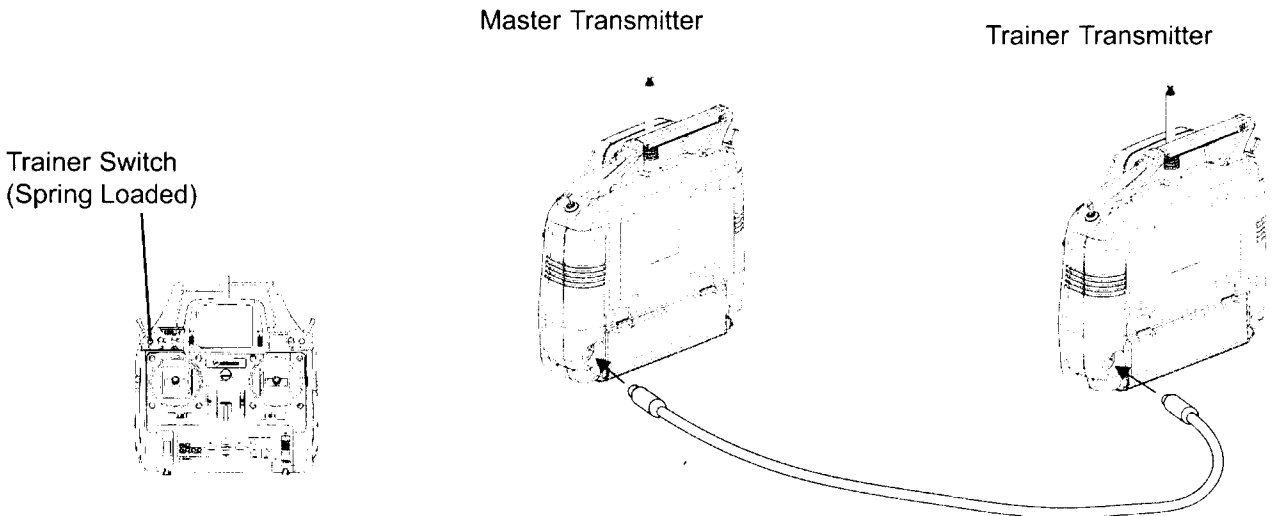

(As long as the instructor holds his Trainer switch in the ON position, the model will respond to the commands of the Trainer transmitter sticks allowing the pupil to fly the model. It is not necessary for the student to hold the trainer switch on the Trainer transmitter.)

When the instructor ceases to stop training, or if he feels that the student is in a situation that endangers the model, the instructor can release the spring loaded switch and control of the model will immediately return to the Master transmitter. To use the Trainer system, you must plug the appropriate Trainer cable into the back of both the Master and the Trainer transmitters. Turn on the Master transmitter and the Model. The cable will energize the encoder section of the Trainer transmitter. Once you have verified that both the Master and the Trainer transmitters will control the model when the spring loaded switch in the appropriate position you are ready to start training.

### NOTE:

Both transmitters must be programmed identically for the trainer system to function properly. All servos must operate in the same direction, centering, end points, and other settings such as type of Modulation must be identical.

## USING THE RD6000 SPORT MICROPROCESSOR

Airtronics has invested a large amount of design effort to ensure that the powerful capabilities of the RD6000 Sport are as simple as possible to use. This manual has been written to offer the user complete instructions for either fixed wing aircraft or helicopter models. The manual is divided into three sections. One for introduction and another for aircraft (both powered and sailplane), and one for helicopters. You only need to read the introduction section and the one that applies to your type of model. In most cases all of the programming of a setup is accomplished through the use of the input keys on the RD6000 Sport transmitter. The function(s) of these are shown below.

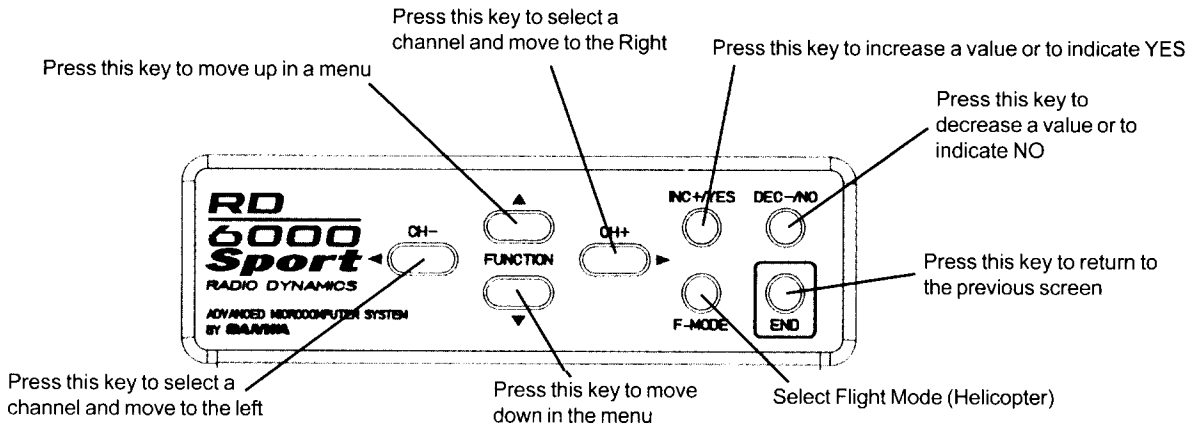

Note: Pressing the INC+/YES and DEC-/NO keys simultaneously will clear a setting and return it to the default value.

## BAR GRAPH VOLTAGE INDICATOR

As a convenience the RD6000 Sport transmitter provides a Bar Graph transmitter battery voltage indicator at the top of the Liquid Crystal Display screen labeled "E" and "F". The "F" symbol indicates FULL and the "E" indicates EMPTY. You can consider it similar to a visible gas gauge. The Bar Graph indicator is in addition to the normal battery voltage that is displayed on the main screen when ever you select either AIR or HELI by pushing the END key twice. When the Bar Graph reads less than half you should not fly until you recharge the transmitter.

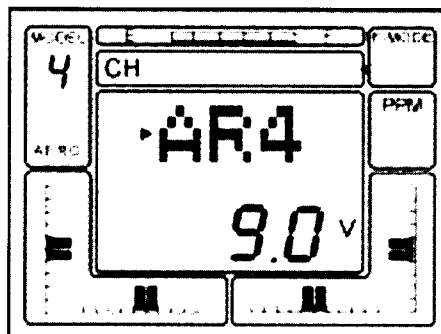

## **RD6000 SPORT AERO FEATURES**

### **FEATURES**

<b>FEATURES</b>	<b>DESCRIPTION</b>
STW (Stopwatch)	Used as a stopwatch or to countdown to a preset time.
REV (Reverse)	Reverses the servo operating direction.
D/R (Dual Rate)	Adjusts servo throw. Available on Elev and Ail.
CNT (Center)	Changes servo neutral position.
TRM (Trim)	The LCD provides an indicator of the value, as well as the direction of the trim.
EXP (Exponential)	Changes the linear movement of the servo to the relation of the stick movement. Can be set Positive or Negative.
EPA (End Point Adjustment)	Limits the total movement of a servo in each direction.
MSL (Model Select)	Select models 1, 2, 3, 4.
MOD (Modulation)	Transmitting Modulation PPM/FM or PPM/Reverse FM.
TYP (Type of Model)	Model Type Aircraft or Helicopter.
INT (Integral Timer)	Used to show how long the transmitter has been in use. Can be reset to zero.
RST (Reset)	Clears all setup data in any model to factory default settings.
CLK (Click)	A beep sound can be heard every time you press a transmitter key. Options Active or Inoperative.
NAM (Name)	You can use up to 3 characters to name your model.
SW-R (Switch Reverse)	You can reverse to default direction of all control switches.
CPY (Copy)	Copy one model to another.
FLAPE (Flaperons)	Activates 2 channels to be used for Ailerons.
DELTA (Elevons)	Ailerons operate as ailerons and as well as Elevators. Used for flying wings.
V-TAIL (Rudder and Elevator)	Used for V-Tail models.
D/A-A (Dual Rate Alarm)	Alerts you when a Dual Rate switch is on. Options On or Off.
T-CUT (Throttle Cut)	You can set the point where the throttle can be cut using the throttle cut-off button.
C-MIX (Compensation Mixing)	Ability to mix a master channel to another slave channel.

## **RD6000 SPORT HELI FEATURES**

### **FEATURES**

### **DESCRIPTION**

STW (Stopwatch)	Used as a stopwatch or to countdown to a preset time.
REV (Reverse)	Reverses the servo operating direction.
D/R (Dual Rate)	Adjusts servo throw. On Elev, Ail and (Rud in Heli Mode)
CNT (Center)	Changes servo neutral position.
TRM (Trim)	The LCD provides an indicator of the value, as well as the direction of the trim.
EXP (Exponential)	Changes the linear movement of the servo to the relation of the stick movement. Can be set Positive or Negative.
EPA (End Point Adjustment)	Limits the total movement of a servo in each direction.
MSL (Model Select)	Select models 1, 2, 3, 4.
MOD (Modulation)	Transmitting Modulation PPM/FM or PPM/Reverse FM.
TYP (Type of Model)	Model Type Aircraft or Helicopter.
INT (Integral Timer)	Used to show how long the transmitter has been in use. Can be reset to zero.
RST (Reset)	Clears all setup data in any model to factory default settings.
CLK (Click)	A beep sound can be heard every time you press a transmitter key. Options Active or Inoperative.
NAM (Name)	You can use up to 3 characters to name your model.
SW-R (Switch Reverse)	You can reverse to default direction of all control switches.
CPY (Copy)	Copy one model to another.
D/A-A (Dual Rate Alarm)	Alerts you when a Dual Rate switch is on. Options On or Off.
T-CUT (Throttle Cut)	You can set the point where the throttle can be cut using the throttle cut off button.
DTM (Dynamic Trim Memory)	Memorizes trims in each flight mode.
GYR (Gyro)	Gyro sensitivity for each flight mode
TH-C (Throttle Curve)	To setup a curve in all flight modes.
PI-C (Pitch Curve)	To setup a curve in all flight modes.
RV (Revolution Mixing)	Tail rotor offset mixing

## SECTION II COMMON FUNCTIONS

The following functions are common and are applicable to both Aircraft and Helicopter sections of this manual. The Liquid Crystal Display shows an Aero model selected; however, a similar screen will be displayed when a Helicopter type model is selected.

NOTE: Switches labeled with red lettering are for aircraft and white lettering is used for helicopter.

### IMPLEMENTATION OF CONTROL FUNCTIONS

In this section you will learn how to implement the control functions and tailor the servo movement and centering for each control. Pressing the END key on the front panel several times will bring you to the following screen, i.e., the initial screen that indicates the current model type and number, PPM modulation and the transmitter NiCd battery pack voltage.

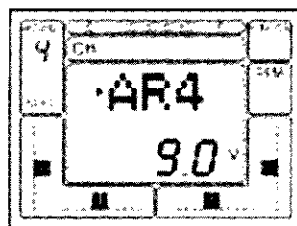
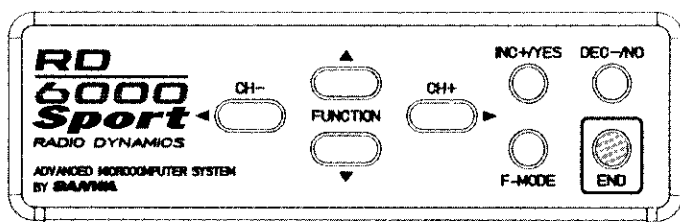

Press the (CH +) key to obtain the STW screen. The Elevator channel will appear on the upper part of the screen. The model number and aero will be present on the left side and the stop watch will indicate zero since no time has been programmed.

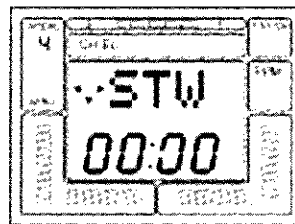
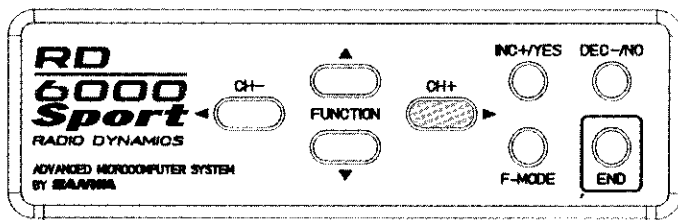

### REV (SERVO REVERSING)

The RD6000 Sport allows you to electronically REVERSE the direction of rotation for each of the servos in use. This allows you to hook up your control linkages and pushrods in the most mechanically desirable manner without regard to the direction of servo movement. After installing your linkages check to see if any of the controls move in the wrong direction when you move the controls. If so proceed as follows for reversing the elevator channel. Reverse for all other channels are done the same way.

Press the FUNCTION down key to arrive at the following screen:

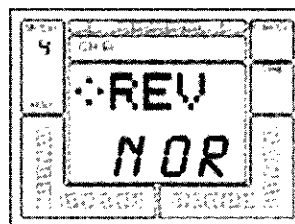
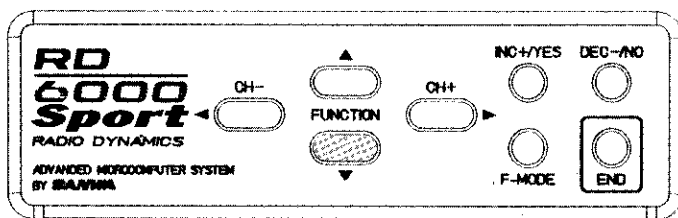

If the Elevator servo moves in the wrong direction, press the INC +/YES key. To move to the Elevator D/R (Dual Rate) screen, press the FUNCTION down key.



## CNT (CONTROL CENTERING)

Your RD6000 Sport allows you to fine-tune the CENTER or neutral position of all flight control servos. After hooking up your controls and mechanically centering all linkages to the approximate positions, press the FUNCTION down key to arrive at the following screen for the Elevator control.

(Note that the Aileron, Throttle, Rudder and Flap centering operates in the same manner when you select that channel on the upper part of the screen. You can move across to the CNT function of each channel as well as some of the other functions by pressing the (CH+ ) key.

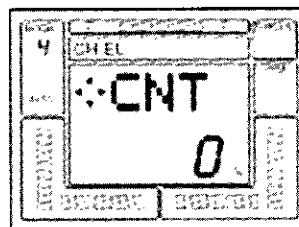
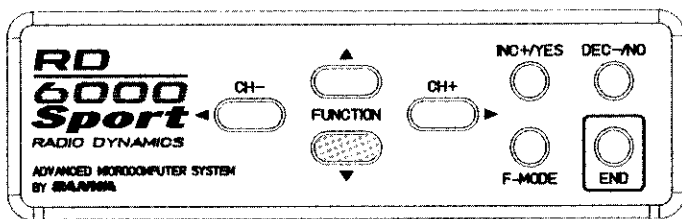

By pressing the INC+/YES or DEC-/NO keys you can vary the value from 0 to + or - 100%. Default is 0%

### IMPORTANT NOTE:

It is desirable to adjust the control linkages as close as possible to the correct center positions, then use the CNT (CENTER) commands to "Fine-tune" the exact position of the control surface when the transmitter control is in neutral.

Using a large amount of electronic centering adjustments will decrease the total throw available for that channel. In particular, centering adjustments greater than + or - 50% will tend to make the extreme stick position on one end less responsive!

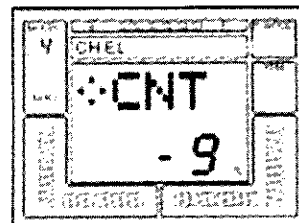
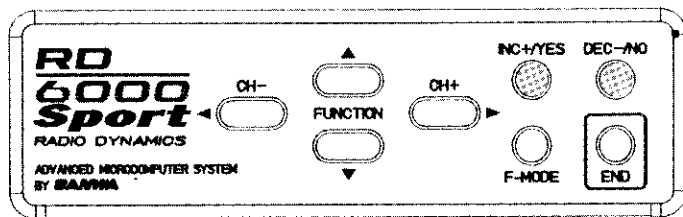

## RST (DATA RESET)

If you want to "UNDO" all of your programmed parameters at one time, you can use the RST function. However, be certain that is what you want to do, since this function will reset all settings to the factory default settings. The RST function will only affect the specific model that you have selected. ALL OTHER Models in memory are unaffected by the RST function.

Press the END key to select the initial AR 1 screen that indicates the Transmitter NiCd pack battery voltage. Now, press the CH + to access the STW (Stopwatch) screen. This screen allows you to move up and down as well as left and right on the screen in the RD-6000 program.

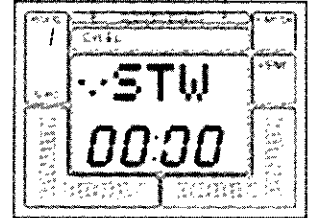
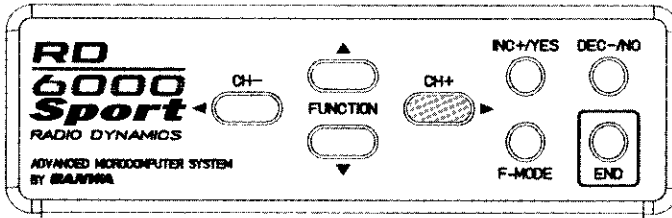

Press the CH + key several times to move across the CH indicator portion of the screen until it reads "etc". Now, press the FUNCTION down key three times to move down in the menu until you reach the RST (Data Reset) screen.

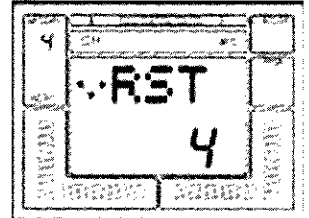
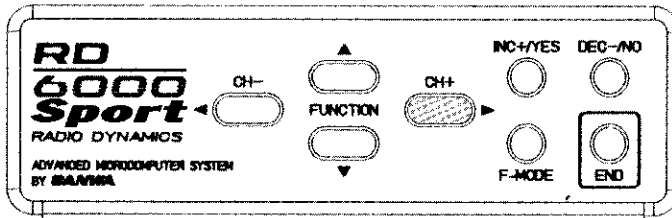

To RESET ALL DATA for this model to default settings press the (CH +) key and the screen will flash YES. Now, press the INC +/YES key and the screen will indicate OK! All parameters on this specific model number have now been reset to default values. Press the END key twice to return to the STW screen.

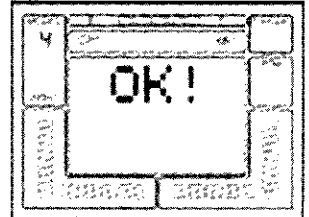
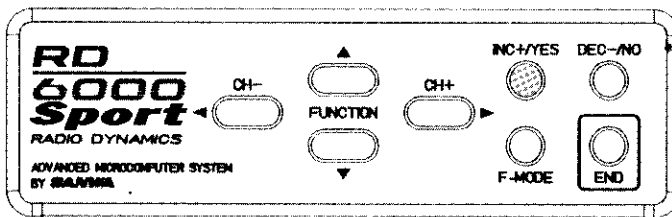

## HOW TO SELECT MODEL SET-UPS: M-SL (Model Select)

The RD6000 Sport has built in memory to store four model setups in any combination of model types. To use or modify one of the model setups you first must select M-SL in the etc menu.

Assume that you want to select a second model. To do so, press the END key to bring up the initial screen that indicates transmitter voltage and model number.

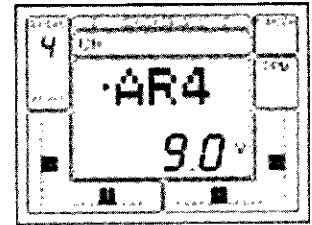
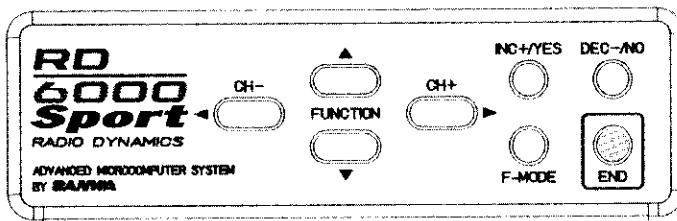

Press the (CH +) key to scroll to "etc". Use the FUNCTION down key to select MSL. Next press the INC +/YES key and the screen will flash MSL to indicate you can select a second model. Press the INC +/YES key again to select the next or following model such as AR2.

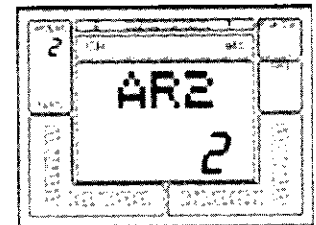
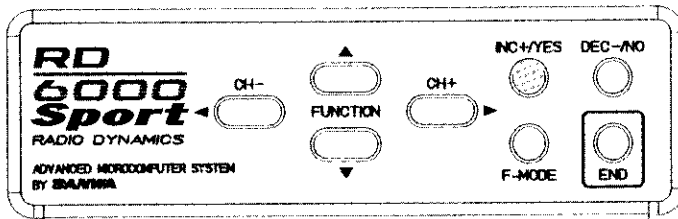

Press the END key three times to return to the initial screen which will show the model number and the transmitter battery voltage reading.

NOTE: if the model type is incorrect, i.e., HELI rather than AERO, continue with the model selection procedure. The model type can then be selected on the TYP screen.

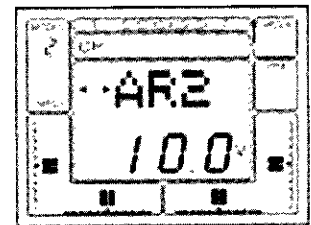
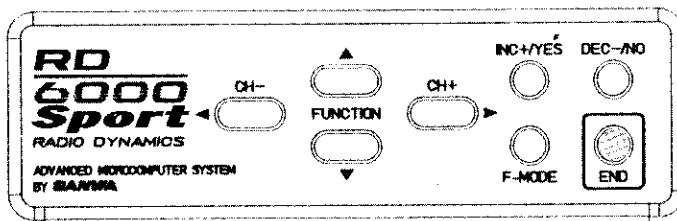

## TYP (MODEL TYPE)

To select the type of model you wish to program, press the (CH+) key to scroll to "etc". Next press the FUNCTION key to select TYP. Now press the (CH+) key to select the next model type, either HELI or AERO. The screen will flash YES with the type of model indicated on the LCD display. To confirm your selection, press the INC+/YES key and the screen will indicate OK!

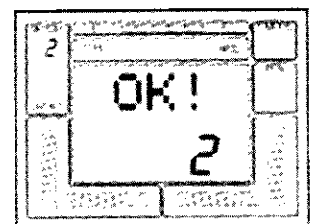
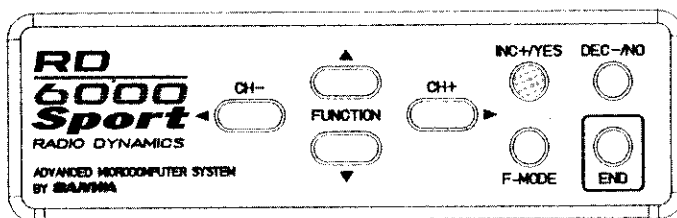

Press the END key three times to return to the initial screen that will then show your model number/type and transmitter battery voltage.

## STW (STOPWATCH)

The RD6000 Sport offers a built-in timer and allows the pilot to use the stopwatch function in either elapsed time mode or in a countdown mode of operation. To use the stopwatch, press either the (CH -) or the (CH +) key to select "etc" on the Channel indicator display.

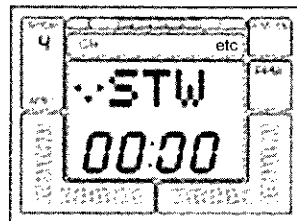
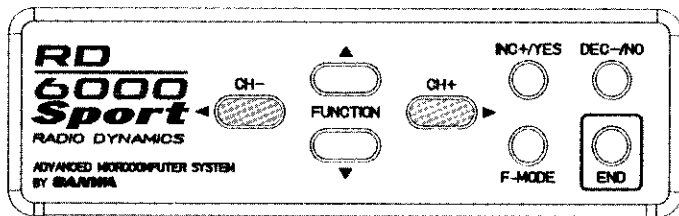

Now press the FUNCTION down key to scroll through the various screen's until you find the STW screen with the flashing >indicator. This is where you can set your stopwatch countdown time. The STW (set) screen is just above the INT screen as shown on the Menu Structure, page 31.

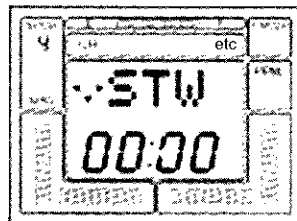
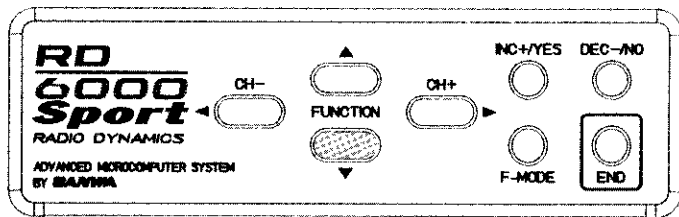

Use the INC +/YES key to set a value for the Start of your count down; as an example set it at 10.00 minutes. The screen will look like the following illustration. If you want to decrease the time, use the DEC - /NO key. If you want to clear the time, press the INC +/YES and the DEC - /NO keys simultaneously.

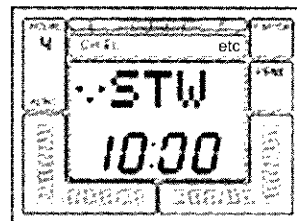
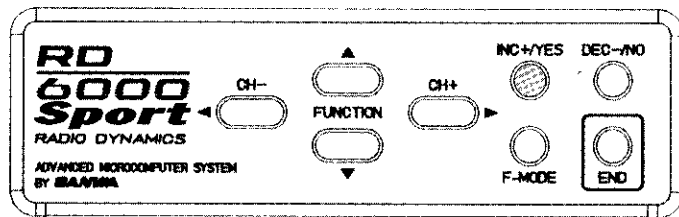

You can now start the stop watch when you are on any of the channel indicator screens that displays the STW screen and the time you previously programmed. Press the INC+/YES key to start or stop the countdown. When the time reaches 10 seconds, a tone will be heard and one will also be heard every second as it counts down to zero. When the timer reaches zero, a steady tone will be heard and it will start counting up. Press the INC+/YES key and DEC-/NO key simultaneously to reset the timer to your previously programmed time.

## INT (INTEGRAL TIMER)

The Integral Timer function of the RD6000 Sport is activated each time the transmitter power switch is turned on, and continues to time up to 99 hours and 59 seconds at all times when the transmitter is turned on. This time will give an excellent indication of how many hours of actual use your RD6000 transmitter has accrued. Or, you may wish to reset the timer to zero at certain intervals, for instance, each time you charge the transmitter NiCd battery pack.

The INT (Integral Timer) function is located in the "etc" column of the menu, directly below STW (set). Use the FUNCTION down key to access the INT screen. Note that it will have some indication of how long the transmitter has been operating. It may look like the following screen, but with a different time shown. The time will show a change for each elapsed second and minute. If you want to reset the Integral Timer to Zero, press the INC +/YES and the DEC -/NO keys simultaneously.

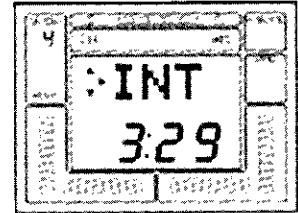
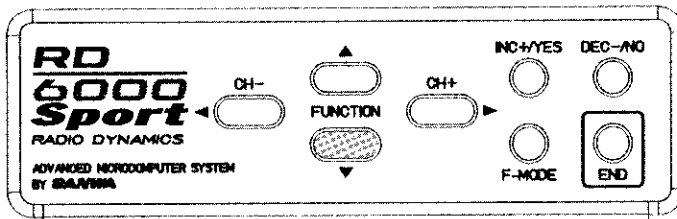

If you desire, you can display the Integral Timer function instead of the STW (stop watch) function on all of the Channel screens. To do so while you are in the INT screen, press the (CH +) key to obtain the following screen.

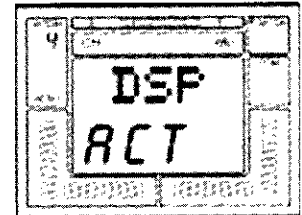
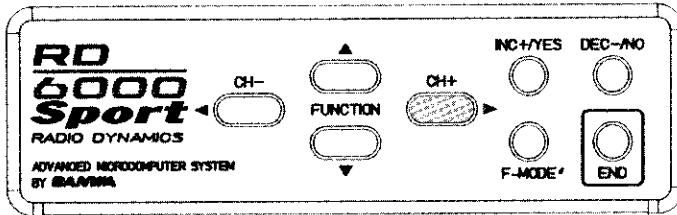

Press the INC +/YES key and the bottom line of the screen will change from INH (inhibit) to read ACT (active). You can press either the DEC -/NO key or the INC +/YES key to change it back to INH. Most pilots prefer to have the Stop watch function displayed on all of their Channel screens, rather than the Integral Timer, therefore, they leave the Integral Timer DSP at INH (inhibit). Press the END key twice to get back to the top of the "etc" menu column.

## NAM (NAMING YOUR MODEL)

The RD6000 Sport provides the capability for you to designate each of the four models you have programmed by use of a 3 digit name. Use the (CH +) key to select the "etc" screen. Press the FUNCTION down key twice to select the NAM screen.

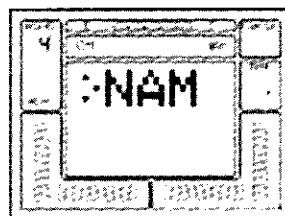
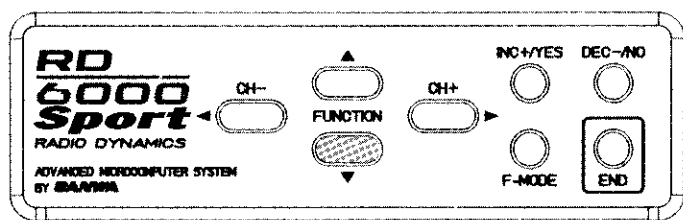

Now press the (CH +) key to select the screen for model number one. The first character will be flashing to indicate you can change that letter.

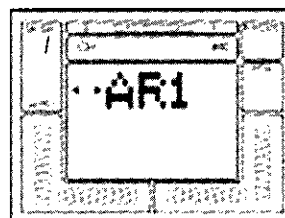
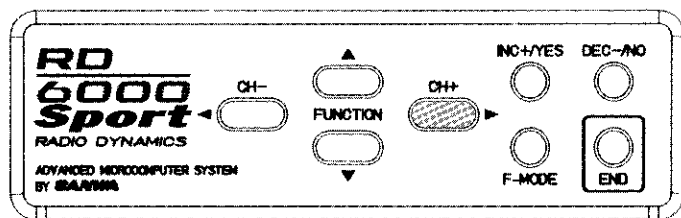

Press the INC +/YES key to scroll through the letters of the alphabet and make a change in the first letter. You may use any combination of LETTERS (upper and lower case), NUMBERS, Colon (:), Dash (-), Character, or blank space to designate a model. When you have finished the first letter, press the (CH +) key to move to the next letter and set it in a similar manner. The DEC -/NO key can also be used to change a letter or number in the opposite direction. Press both the INC +/YES and DEC -/NO keys simultaneously to return to the default setting of AR 1. Once you have completed designating your present model, press the END key twice to return to the "etc" column heading.

## EXP (EXPONENTIAL)

The RD6000 Sport allows the pilot to choose two settings for Exponential throw for each of the primary flight channels, Elevator, Aileron (and Rudder in helicopter mode).

Exponential throw is primarily used to “soften” or decrease the control stick sensitivity of a control around the neutral point. With Exponential disabled, a control function servo will move in an amount proportional to the amount of control stick deflection, i.e., 50% stick deflection will result in 50% servo travel; 75% stick deflection will cause the servo to travel 75% of its presently set maximum throw.

Exponential settings DO NOT change the amount of travel available at 100% stick deflection, but rather it changes the amount of the servo travel that will occur with stick deflections less than 100%. The first 25% of stick deflection may be set to result in only 10% of total servo throw making the control less sensitive around neutral. See the following illustrations.

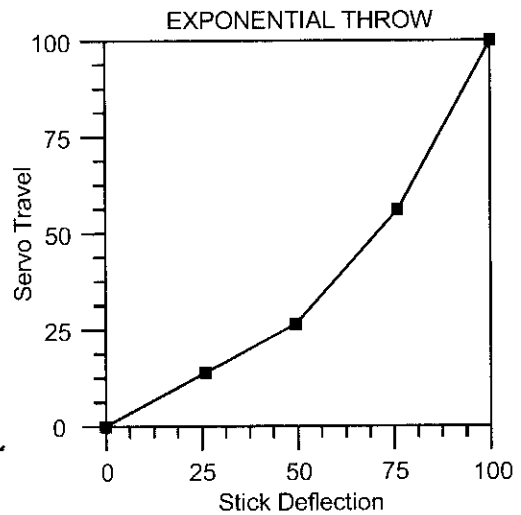
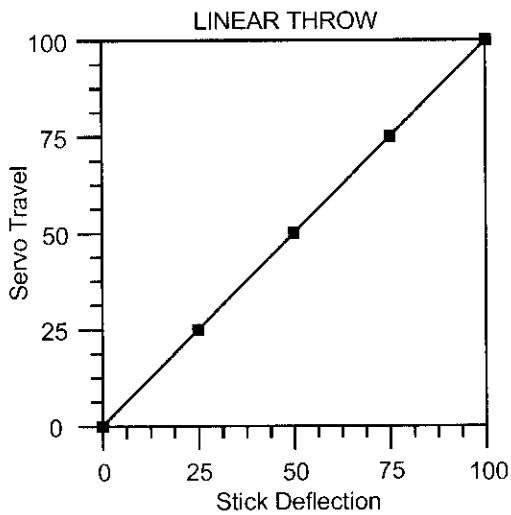

If you have used Exponential functions before, you will want to start with a small amount of Exponential (10 to 20%) to determine whether you like this sort of control response. Exponential is most useful where strong control response is desired at extreme stick positions but softer response to small stick movement is desired in order to make very accurate small corrections to flight path.

The switch positions for Exponential #1 and Exponential #2 correspond to the Dual Rate switch positions of Elevator and Aileron. Exponential #1 is with the Dual Rate switch in the down i.e., Off position. Exponential #2 is with the Dual Rate switch UP i.e., ON position. (Note however that you can leave the Dual Rate adjustments for Elevator and Aileron set at 100% which is no rate, so that switching a Dual Rate switch ON will activate Exponential only.

NOTE: Setting the Exponential with a positive number will make servo movement soft in the neutral area of the stick movement. Setting the Exponential with a negative number will make servo movement faster in the neutral area and softer at the end of the stick travel.

As an example, to set Exponential for elevator, access "EL" in the Channel area by using the (CH+) key.

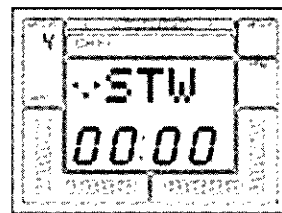
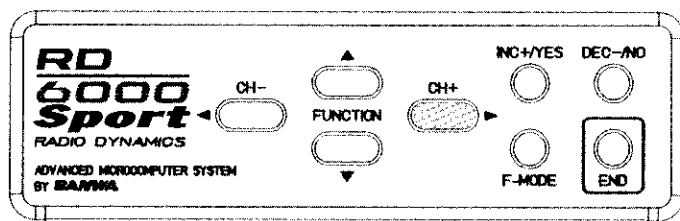

Now press the FUNCTION down key to select the EXP display for the Elevator Channel as shown below.

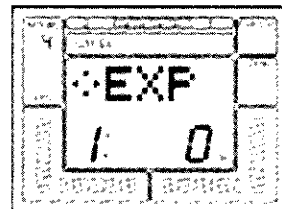
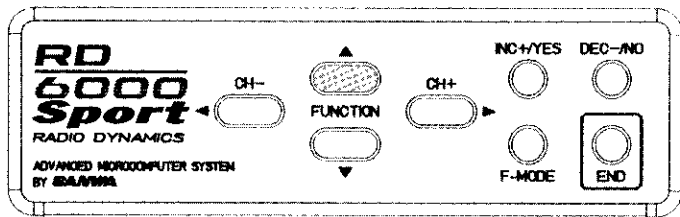

This screen tells you the present Exponential status of the elevator channel and when a Dual Rate Exponential switch is set to ON position, the Exponential setting for that control function. The possible range for Exponential settings is from -100% to +100%. Note that 0% is linear. A negative value will speed up the response and it will make the stick movement more sensitive around the neutral position.

To set an EXponential rate in this example, turn the Dual Rate switch for Elevator to the ON upward position. Note that the display changed to Exponential #2. You can set the value for the Elevator channel Exponential. Press the INC+/Yes key to set a positive value of Exponential function as indicated below.

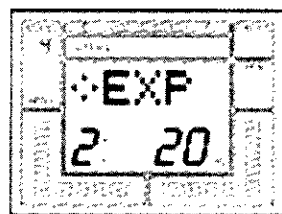
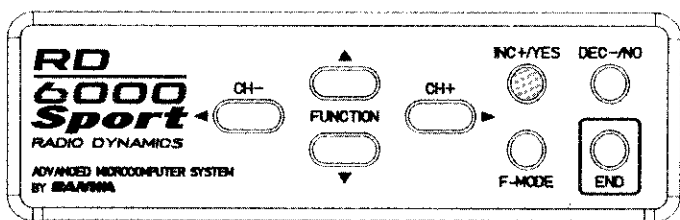

In the above example we set Exponential #2 to be 20% of the maximum for the Elevator channel. This is a good starting point for determining the suitability of Exponential throw for your aircraft and flying style.

You can actually have two different Exponential settings if you desired. One for switch position #1 and another for switch position #2. However when you first start using Exponential throw, it is usually best to leave the switch #1 position at 0% which is linear throw.

In general, large amounts of Exponential are useful only in instances where very large control surface deflection is required at extreme throw, while very small amounts of control response are necessary for smaller control stick inputs. One example of models for which large Exponential settings may be useful is the highly maneuverable "Competition FUN FLY" style models. For most sport and aerobatic models, an Exponential setting from +10% to +25% will give the desired "softness" around neutral.

**CAUTION:** Proceed with care when setting Exponential functions to ensure that you will have adequate control deflection available in any possible switch position. Setting Exponential to a very high or 100% setting will require very large stick movements to achieve small control responses. Always make sure that you are aware of the present status of any rate assignments that you have selected! For the most flexibility in setting up an aircraft model to your liking, study the available options for Dual Rates, End Point Adjustments, and Exponential. The combinations possible when using these options allows for several possible set-ups. The Exponential for the Aileron Channel is set in the same manner as done for the Elevator. The AI D/R switch located above the right stick assembly is then used when setting the Exponential Throw.



## MOD (MODULATION)

An extremely versatile feature of the RD6000 Sport transmitter is the capability to select two different types of modulation. These are PPM/FM for standard FM receivers and PM/FM-Reverse for "other brand" receivers. To access the Modulation screen, press either the (CH -) or (CH +) key to select the "etc" screen.

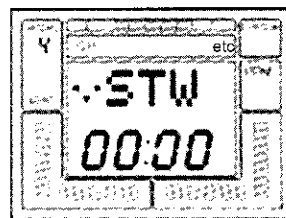
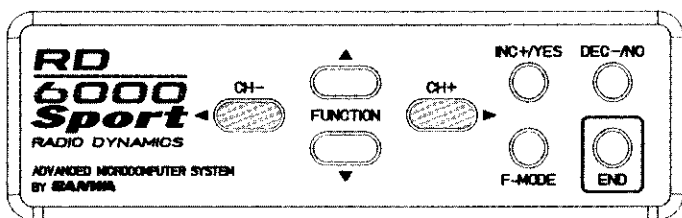

Next, press the FUNCTION down key to select the MOD (modulation) screen. It will show PP indicating the present selection is PPM/FM.

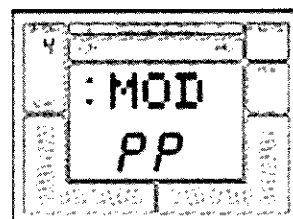
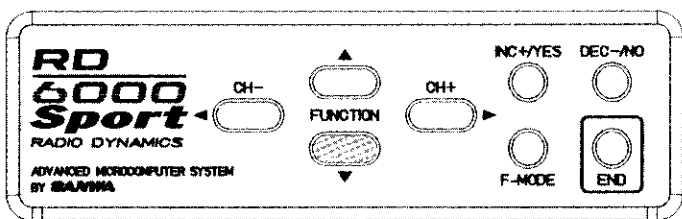

If you want to change the Modulation, press the INC +/YES key and the presentation will change to the following screen. Note that the small Modulation Indicator on the right side of the screen will also show the present modulation selection when it is changed, except when you select PPM/FM Reverse.

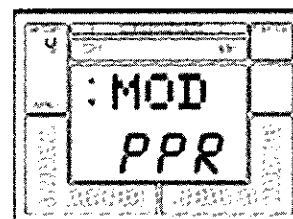
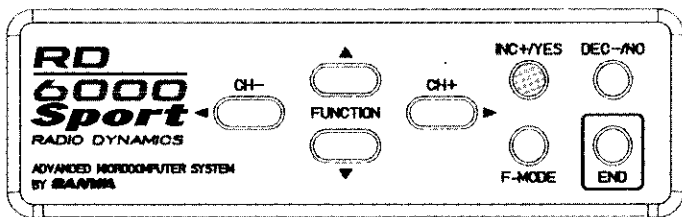

Press both the INC +/YES and DEC -/NO keys simultaneously to return to the default PP (PPM/FM) modulation. Press the END key to return to the STW screen.

## CPY (DATA COPY)

A valuable feature of the RD6000 Sport is the Data Copy Function. With this function the entire set of control parameters for one aircraft can be 'copied' from one model set-up into another. (For instance, if you have your aircraft program in Model #1 and nothing in Model #3, you can copy the Model #1 program into Model #3 with the copy function.

Having copied your control set-up, you can now use MSL (Model Select) to access the Model #3 program and then make control changes to that set-up. This allows you to experiment with different control options without changing your original parameters (in this example Model #1).

To use the CPY (copy) function, select "etc" on the Channel indicator using either the (CH -) or (CH +) key. (note that you must be on the STW screen to move horizontally across the screen to "etc").

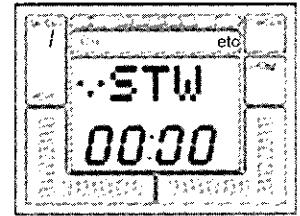
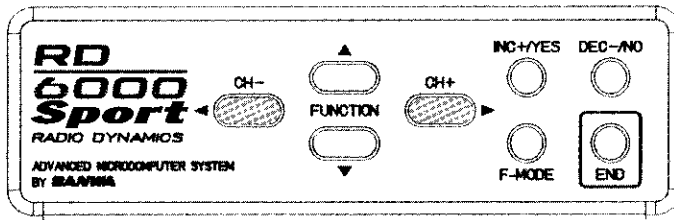

Press the FUNCTION down key to select the CPY (copy) Function.

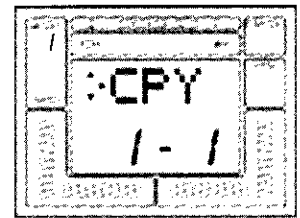
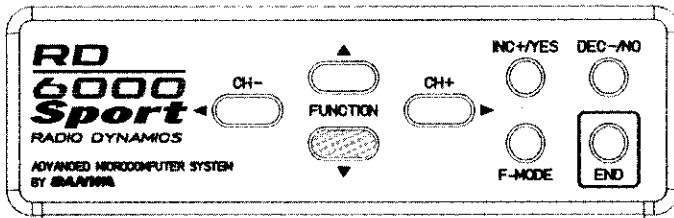

For this example, assume you want to copy the set-up of Model #1 (which you selected), to Model #3. The first number on the screen indicates the model number of the model you are copying. The second number indicates the destination of the model being copied. Press the INC +/YES key to change the destination for the copy to indicate Model #3. Note that one of the small triangles is blinking which indicates there is another screen associated with this function.

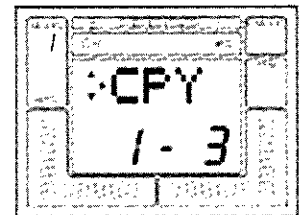
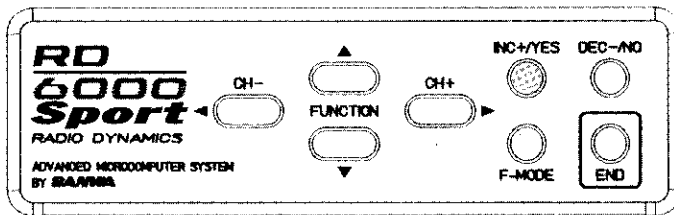

On the previous screen, the destination has been set to Model #3. **MAKE CERTAIN** that this model setup is not one you wish to save, because when you copy the Model #1 set-up into Model #3, all data that was in Model #3 is replaced with the Model #1 data! At this point Model #3 data is still intact, so if you wish to change the destination for the copied data, do so before proceeding.

Having selected both the data source (Model #1) and the desired destination (in this example Model #3), you can now proceed to confirm the copy function.

Press the CH + > key to access the next screen as shown below. The "YES" will be blinking.

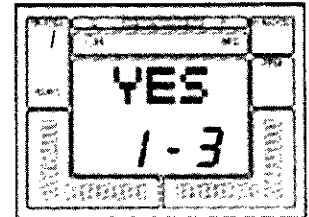
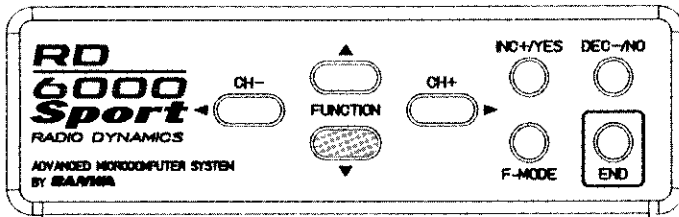

Press the INC +/YES key to confirm your data copy function. The screen will change to the following screen to inform you that the process has been completed, and that Model #1 and Model #3 now have the same data, (in this example Model #1).

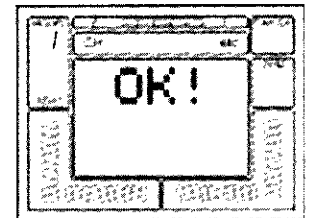
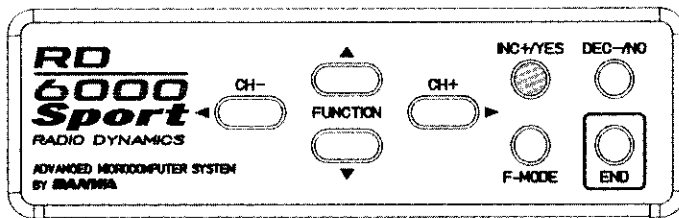

Press the END key to return to the CPY select screen.

## SW-R (SWITCH REVERSE)

The SW-R Function allows you to reverse the action of the five toggle switches located on your RD6000 Sport transmitter. The default of the SW-R Function is in the NOR (normal) position. CAUTION! The switch reversal function is not selective. If you change it from NOR (normal) to REV (reverse), all switches will be reversed in their action!

To access the SW-R Function, select "etc" on the Channel indicator using either the (CH -) or the (CH +) key. ( Note that you must be on the STW screen to move horizontally across the screen to "etc")

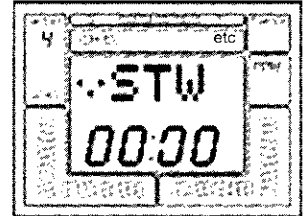
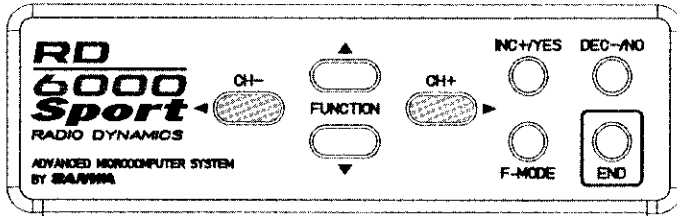

Press the FUNCTION down key to scroll down to the SW-R (switch reverse) screen.

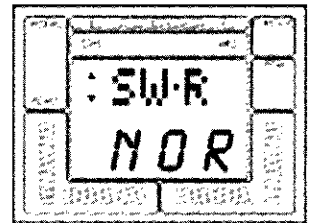
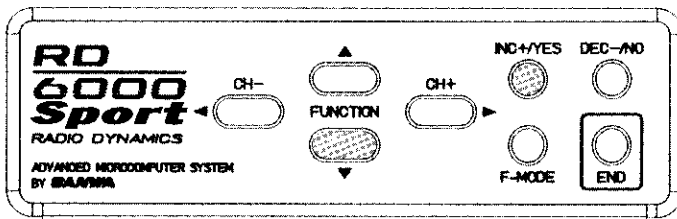

Now, press either the INC +/YES or the DEC -/NO key to change the indication from NOR to REV. All switches on the transmitter are now reversed in their function. Press END to return to the STW screen.

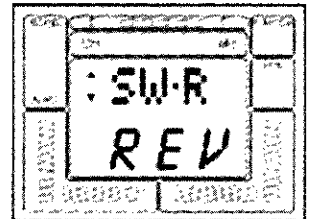
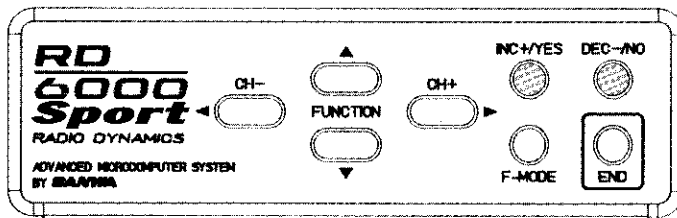

## CLK (CLICK)

The RD6000 Sport transmitter normally is set to emit an audio tone when ever the programming keys are pressed, when values are changed and when the stop watch function is started, stopped or reaches the final ten seconds of count-down.

It is possible to disable the "Click" or audio tone, using software settings. When the "Click" tone is disabled, ONLY the stop watch count-down will still cause an audio tone to be emitted.

To set or disable the "Click" function, select "etc" on the Channel indicator using either the (CH -) or the (CH +) key.

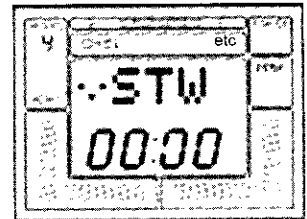
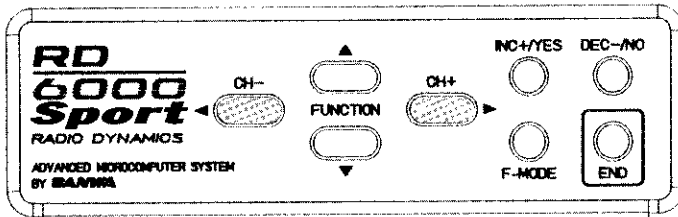

Press the FUNCTION down key to access the CLK (CLICK) screen.

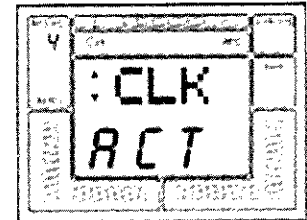
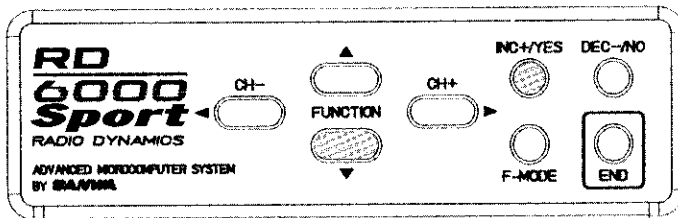

Press the INC +/YES key to change the indication from ACT to INH, to disable the Click function. (pressing either the INC +/YES or the DEC -/NO key will toggle the function between "INH and "ACT" settings)

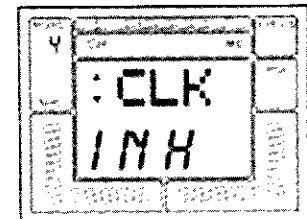
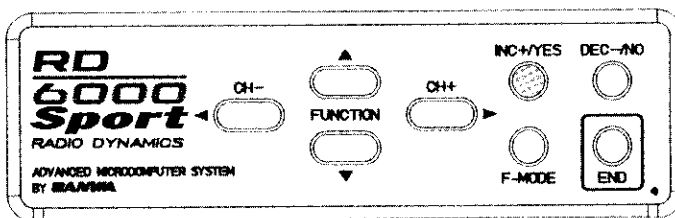

Press the END key to return to the STW screen.

## T-CUT (THROTTLE-CUT)

Another useful function provided by the RD6000 Sport for engine powered models is T-CUT, Throttle Cut. Normally you set your throttle stick in the extreme low position and use EPA and the digital trim to obtain a steady low engine idle speed. However, if you want to stop the engine at the end of the flight you would have to use the throttle digital trim and later re-trim for proper idle. The T-CUT function solves this problem by providing a push button that, when pushed, overrides the throttle sticks low throttle position and drives your throttle servo to a lower position, stopping the engine. The throttle stick must be in the low position for the throttle cut to function.

In order to use T-CUT, press either the (CH -) or the (CH +) key to select TH on the Channel indicator.

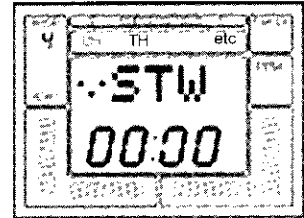
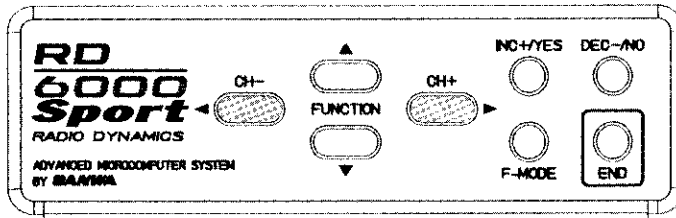

Next, press the FUNCTION down key several times to obtain the following screen.

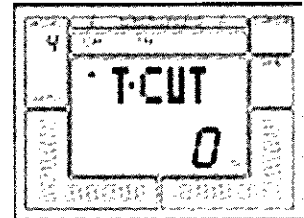
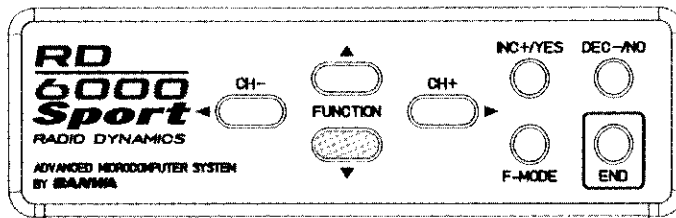

Press the DEC -/NO key to set a value of -100%. Place the throttle stick in the extreme low position. Press and hold down the Throttle Cut push button located above the elevator/aileron stick assembly. The throttle servo will then rotate further to close the engines carburetor and stop the engine.

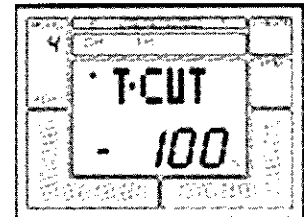
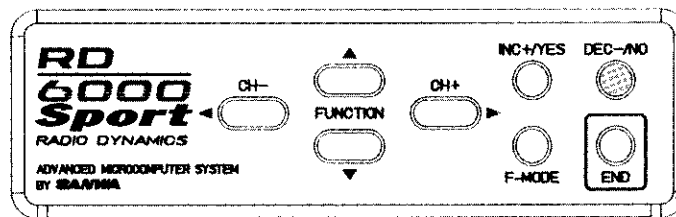

RD6000 Sport USERS MANUAL - AIRCRAFT

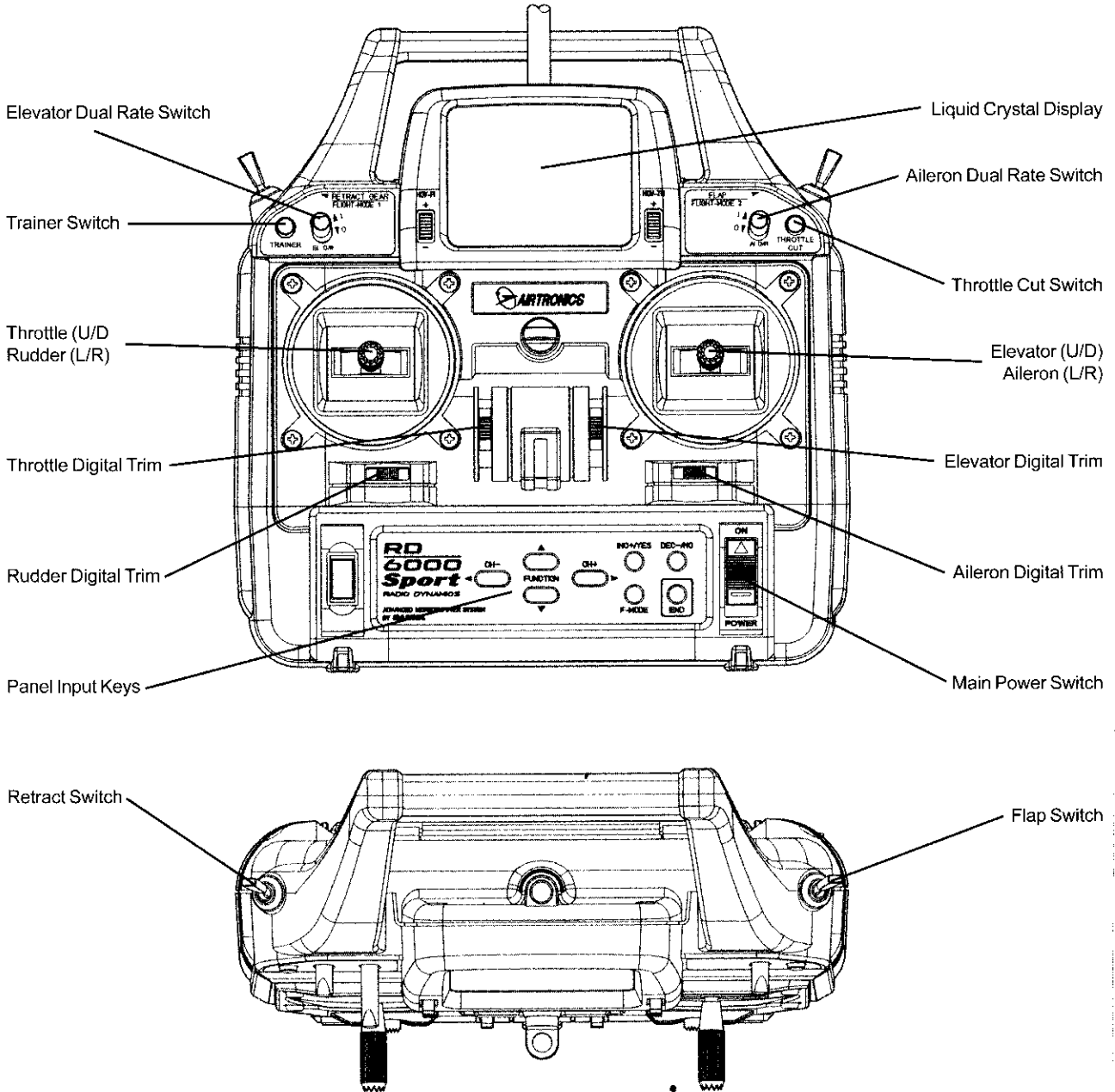

92777 Receiver Channel Assignments	
Receiver Plug Number	Plug in Servo For:
1	Elevator
2	Aileron
3	Throttle
4	Rudder
5	Gear
6	Flap or 2nd Aileron Servo
7/B	Battery

# AIRCRAFT MENU STRUCTURE

(Rx Channel)	CH	EL	AL	TH	RU	G	P/F	etc
		STW	STW	STW	STW	STW	STW	STW
		TRM	TRM	TRM	TRM	REV	TRM	M-SL
		REV	REV	REV	REV	EPA	REV	NAM
		D/R	D/R	CNT	CNT		CNT	MAS-1
		EXP	EXP	EPA	EPA		EPA	SLV
		CNT	CNT	T>E				E>E
		EPA	EPA	T-CUT				MAS-2
			A>R					SLV
								E>E
								STW set
								INT set
								TYP
								SW-R
								CPY
								RST
								MOD
								CLK
								FLAPE
								DELTA
								V-TAIL
								D/R-A

Use the four center buttons in the function panel to navigate through the menu's. (UP / DOWN / LEFT / RIGHT)

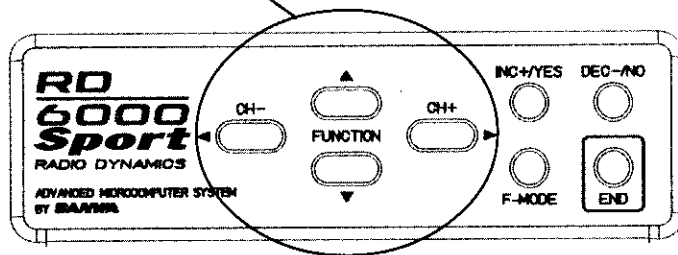



## PROGRAMMING FOR AIRCRAFT

### INITIAL SET-UP OF TYP (MODEL TYPE)

When you receive your RD6000 Sport unit the transmitter is preprogrammed for both fixed wing aircraft model's as well as for helicopter models as follows:

- Model #1 is setup with AERO featuers (AR1)
- Model #2 is setup with HELI featuers (HL2)
- Model #3 is setup with AERO featuers (AR3)
- Model #4 is setup with HELI featuers (HL4)

If you fly only fixed wing model aircraft, you can change both model's 2 and 3 to aircraft.

Turn the transmitter power ON and press the END key untill you come to the default main screen. The inital screen will show AR1 which indicates the aircraft type as well as showing the NiCd battery voltage.

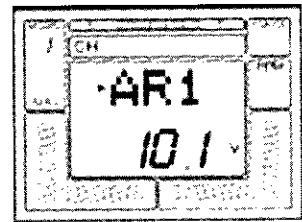
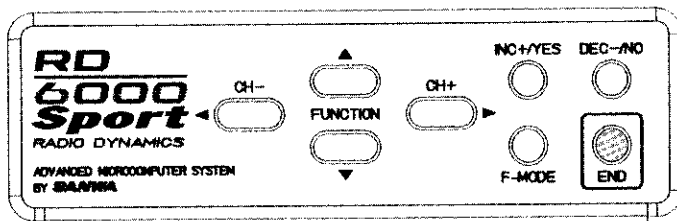

Press the (CH+) key to scroll across the CH (channel) indicator on the screen to "etc".

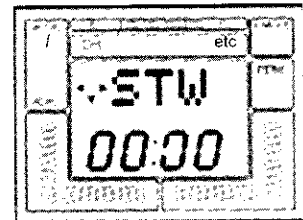
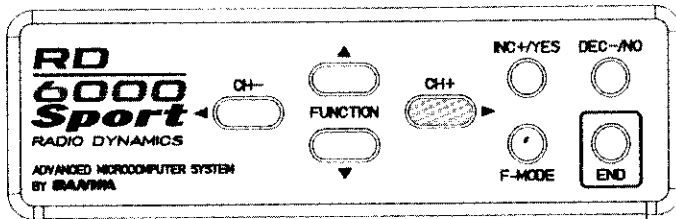

Press the FUNCTION down Key once to access the MSL (model select) screen.

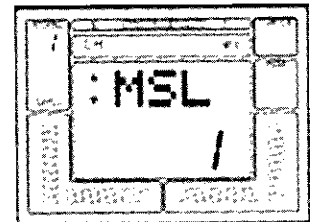
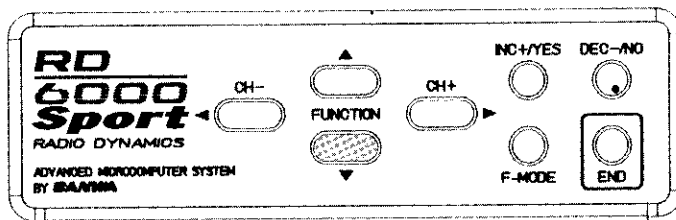

Next, press the INC+YES key until the screen reads HL2 (heli model 2). Now press the END key and the screen will show that you have selected model number two which is a helicopter setup. However, since you are a fixed wing aircraft pilot, you want all of the transmitter setups to be fixed wing aircraft. The TYP (type) of aircraft must be changed from Heli to Aero.

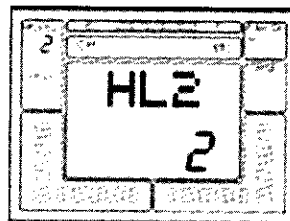
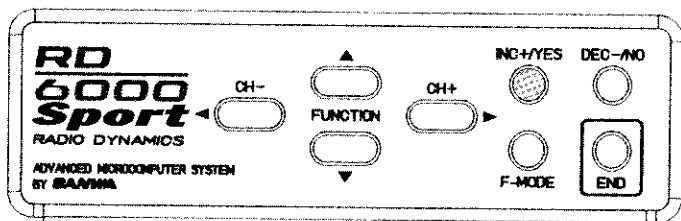

### TYP (Type of Model)

To change the type of model, press the FUNCTION down key to select the TYP (model type) screen.

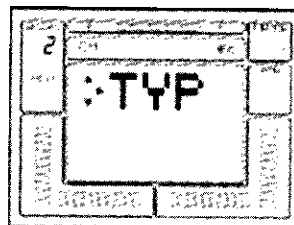
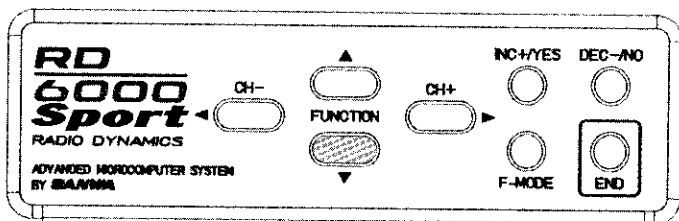

Note that one of the small triangular indicators will be blinking to show that you should press the (CH+) key. Therefore, press the (CH+) key and the screen will change to AERO with a flashing YES.

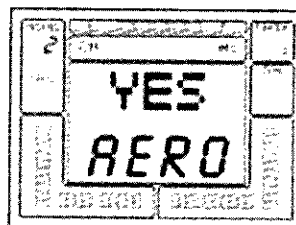
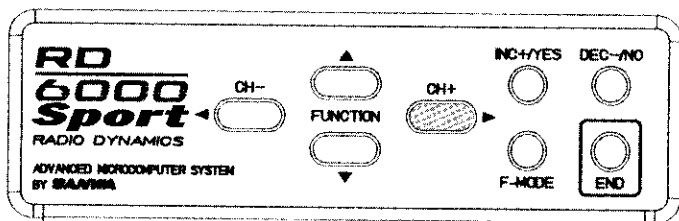

To confirm the change of aircraft type, press the INC+YES key. The screen will then change to read OK! As shown on screen below to indicate the model type has been changed to AERO from model #2. Press the END key twice to return to the STW screen. The same procedure as noted above can be used to change model #4 from HELI to AERO.

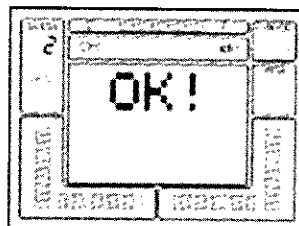
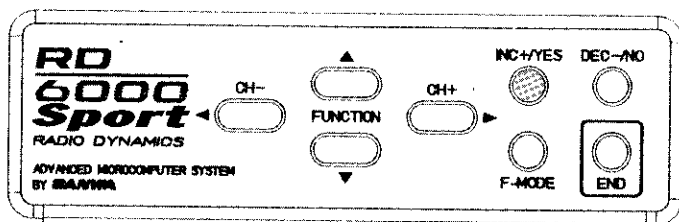

## D/R (DUAL RATE)

Dual Rate adjustments allow you to switch from your "standard " control deflection to a reduced amount of throw by simply flipping a switch. The Actual speed of signal processing and servo movement are not affected by the Dual Rate settings, only the amount of total throw available.

The RD6000 Sport allows Dual Rate settings for Aileron and Elevator. To access the Dual Rate setting for Elevator when you are on the STW or REV screen, press the FUNCTION down key to reach this screen.

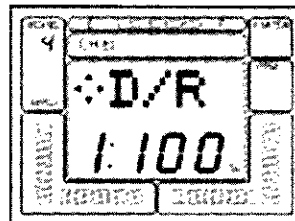
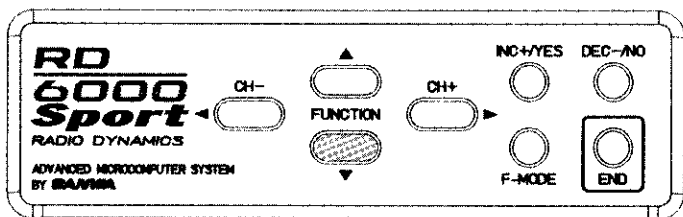

The screen tells you the present rate status, and when a Dual Rate is set to the ON position, the alternate rate for that control function that is presently set in the program. It is important to understand that the term "Dual Rate" is used because it is an old and familiar description. We are showing an example for the Elevator channel, however, all of the other channels are set in the same way.

The Dual Rate setting can be varied from 0 to 150%. Default for Dual Rate 1 is 100%. We recommend you leave it at that setting and only change the setting for Dual Rate 2, i.e., when the Dual Rate Switch on the upper left side of the transmitter panel is turned ON. The normal convention for Dual Rate reduced throw is the switch in the UP position to Turn ON Dual Rate. When you do so, note that the Screen will appear as follows. Press the INC +/YES or DEC -/NO key to increase or decrease the value. An initial setting of 50% is a good starting point and you can tailor it later following a test flight.

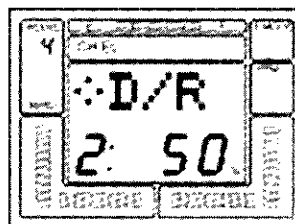
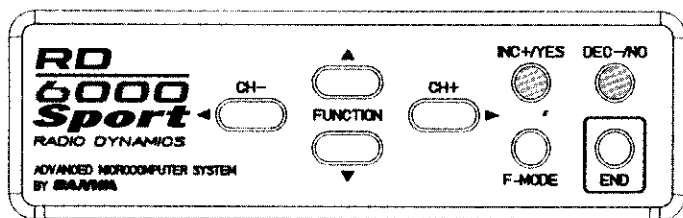

The Dual Rate switch for Aileron is located above the right stick assembly and is labeled AI D/R. Aileron Dual Rate is programmed similar to that as done for Elevator. To set it for Aileron, place the AI DR switch in the upper position and use the DEC -/NO key to reduce the value shown on the screen to something less than 100%.

**CAUTION:** Prior to taking off your model, check the position of both of your Dual Rate switches to make sure they are in the position you want!

## EPA (END POINT ADJUSTMENT)

The RD6000 Sport allows you to adjust the "End Points", or travel limits, for all flight channels.

In general, it is best to use as close to 100% servo throw as possible. This allows for the best possible resolution and centering of all control surfaces. However in some cases it is not possible to use full servo movement such as those instances where short control horns must be used because of aircraft design considerations, or with fixed length control horns such as a throttle arm.

Assume we want to adjust the EPA of the Elevator channel servo. To electronically do so, we first bring up the STW (stopwatch) screen as previously instructed in INITIAL SETUP. Next press the FUNCTION down key until the EPA screen appears for the Elevator channel.

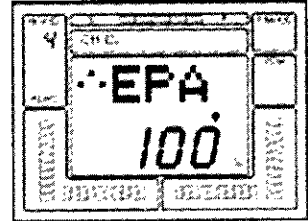
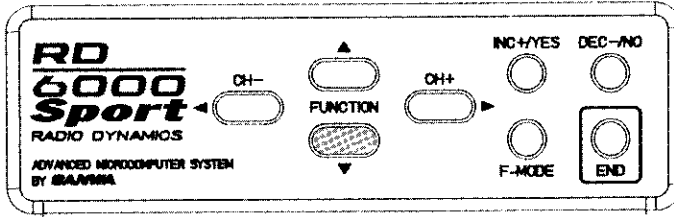

The EPA of the Elevator channel can be adjusted from 0% to 150%. By moving the elevator stick up and down, you will see the LCD arrow change according to the direction you are moving the stick. To set the UP EPA, move the stick back past the neutral position and release the stick. You can increase or decrease the amount by using the (INC+) or (DEC-) function keys.

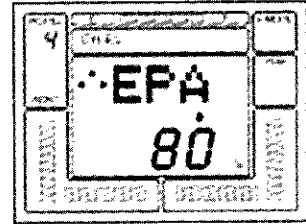
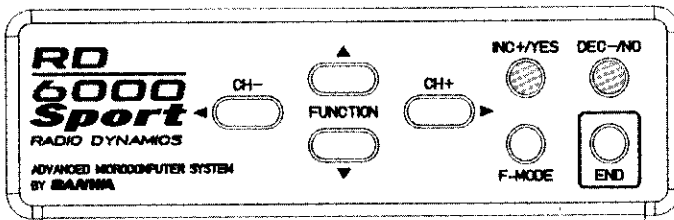

Note that you can move across the menu using the (CH+) or (CH-) keys to adjust EPA for all other channels. To adjust the EPA on Gear and Flap channels simply move the toggle switch up or down and adjust the EPA accordingly.

## G (Landing Gear End Points)

In most cases, (almost all cases in the past) the total servo throw for the landing gear function could not be set by the transmitter, because most retract servos are SWITCHED (non-proportional) servos. With these servos, mechanical adjustment is the only method available to ensure proper operation of the retracts.

Airtronics now offers a high Torque PROPORTIONAL retract servo, p/n 94739. With this servo and the RD6000 Sport transmitters, End Point Adjustments for the retract servo are possible, independently setting the "Down" and "UP" lock positions in mechanical retracts, and precise adjustment of the air valve in pneumatic retracts.

To use this function, select the EPA function as shown on the previous screen.

Press the (CH +) key to scroll across the Channel indicator on the screen until you reach G (Landing Gear).

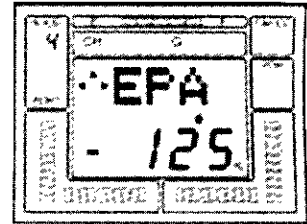
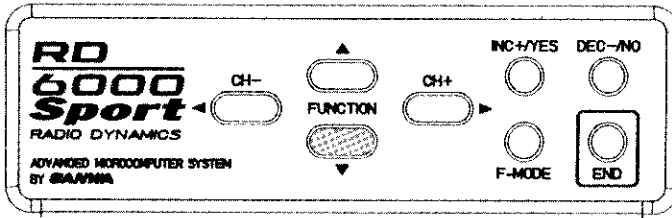

Note that you must set the value for UP and Down landing gear by use of the INC +/YES and DEC -/NO keys.

Activate the Landing Gear toggle switch located on the upper left top of the transmitter when setting the values for the Landing Gear. You can vary each one from 0% to 150%. The default values for Landing Gear are -125% and +125%.

To restore the landing gear channel to the default values, press the INC and DEC keys simultaneously.

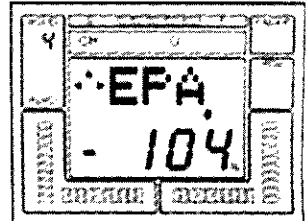
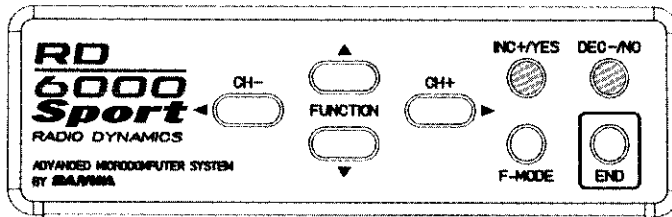

Press the END key to return to the STW screen.

## TRM (TRIM MEMORY)

The RD6000 Sport offers the Trim Memory Function on all four of the flight control channels. Trim Memory for Elevator, Aileron, Throttle, and Rudder is input by the Digital Trim keys set when you use the INC +/YES or DEC -/NO keys to input trim.

Any trim that you set while your model is in flight by use of the Digital Trim keys will automatically be stored in memory for that specific channel and model.

The Trim value in % that you set during flight is shown on the TRM screen for each Channel. In addition, there are bar graph indicators on the screen at all times that visually show how much trim has been set for Elevator, Aileron, Throttle and Rudder channels.

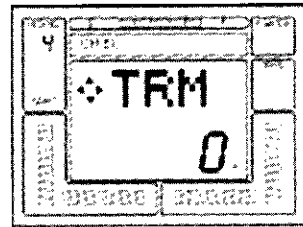
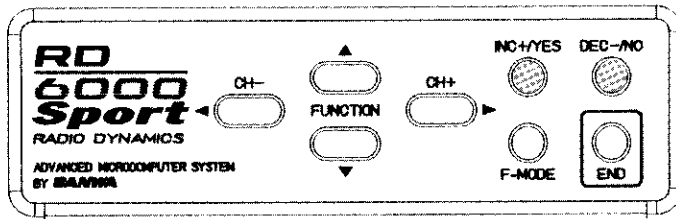

## FLAPE (FLAPERONS)

The Flaperon function can be used to just obtain two separate aileron channels with a servo in each wing. It can also be used so that the strip ailerons act as flaps and deploy in a downward direction to create both lift and drag. In the following example, the ailerons will be programmed to act as flaps that are controlled by the Flap/FL-EL switch.

Press the (CH -) or the (CH+) key to select "etc" on the Channel indicator.

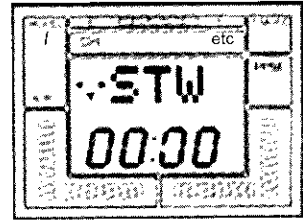
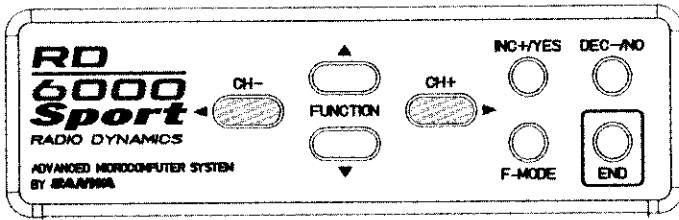

Next, press the FUNCTION down key several times to see the following screen.

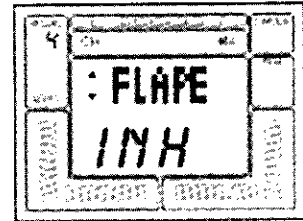
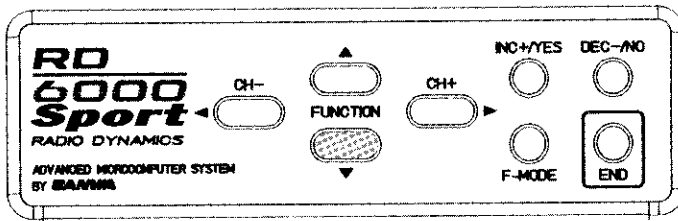

Now, press the INC +/YES or the DEC -/NO key to set the FLAPE function to ACTIVE. The aileron stick will now operate two servos on receiver channels #2 and #6. Press the END key to return to the STW screen at the top of the menu.

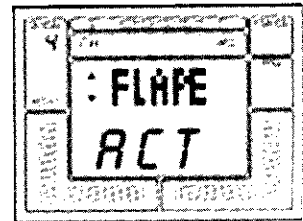
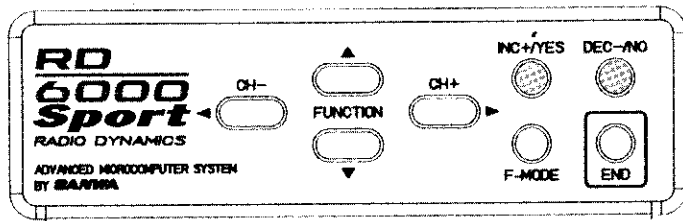

Press the (CH -) key to select p-f on the CHannel indicator.

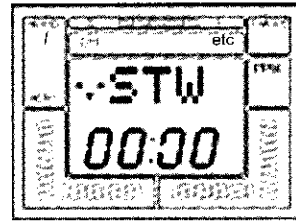
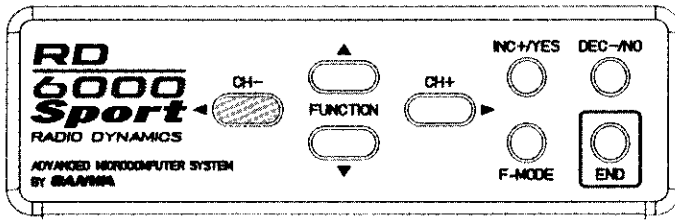

Use the FUNCTION down key to scroll down to FLAP EPA (endpoint adjust). Note that the default setting is -100%. Range of adjustment is from -150% to +150%. Press either the INC +/YES or the DEC -/NO key to change the value an/or polarity of the function. The FLAP/FL-EL switch located on the top-right of the transmitter activates the Flaperons. To disable the Flap switch, set the Flap EPA at 0%.

Note that if the ailerons go up when the Flap switch is activated, change the polarity of the programmed value. Use the FLAP TRM (trim) function to fine tune flap operation.

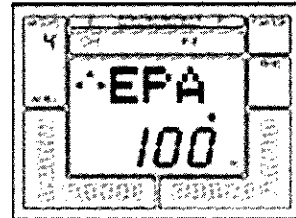
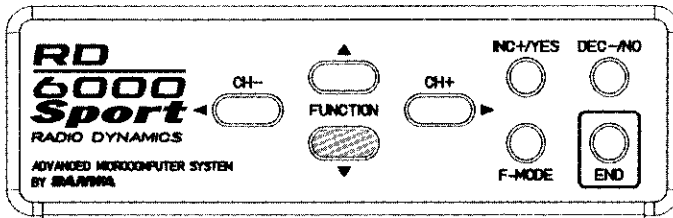



**ALARMS**  
**D/R-A(DUAL RATE ALARM)**  
**THROTTLE STICK HIGH**

The RD6000 Sport offers an "ALARM" function to warn you if you turn your transmitter on while a Dual Rate Switch is activated, and another to warn you if you turn the transmitter on while the Throttle Stick is in any position other than Full-Low throttle. TH-Hi! Will be displayed on the LCD screen until you place the Throttle stick in the full-low position.

To activate the D/R-A (Dual Rate alarm), press the (CH -) or the (CH +) key to select "etc" on the CHannel indicator.

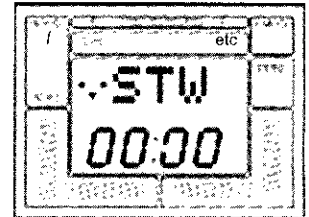
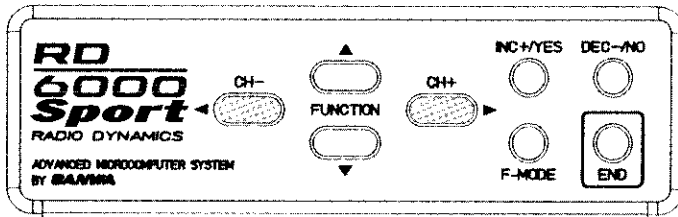

Press the FUNCTION down key several times to scroll down the menu items and select the D/R-A screen.

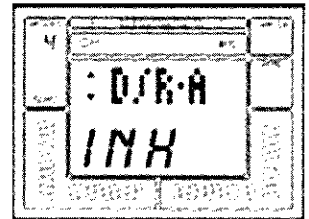
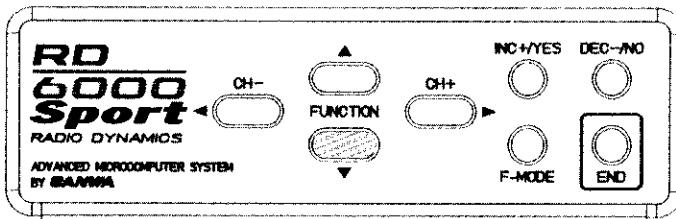

Next, press either the INC +/YES or the DEC -/NO key to set D/R-A to ACTIVE.

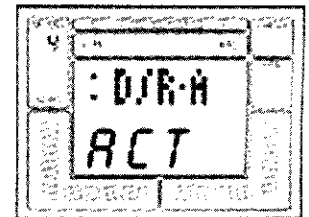
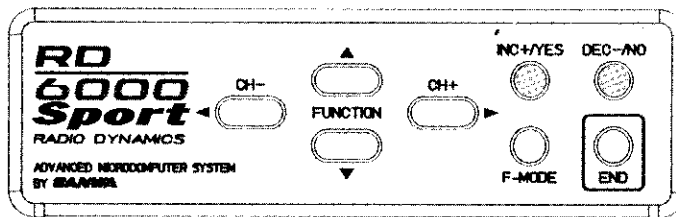

If a Dual Rate switch is in the ON position when you turn ON the transmitter, an audio tone signal of 3 beeps will occur at approximately every 15 seconds until you turn off a dual rate switch.

If you wish, you can turn off the Dual Rate alarm by pressing either the INC +/YES or the DEC -/NO key to change D/R-A to INHibit.

Note that the High Throttle Stick alarm is always active.

NOTE: The RD6000 Sport transmitter will also sound an alarm if the power switch is left on for a period of time that exceeds 15 minutes.

## DELTA (ELEVONS)

DELTA mix can be used in a flying wing type model to provide ELEVON control, where the elevator and aileron functions are combined.

To access the DELTA function, use either the (CH -) or the (CH +) key to select the STW screen.

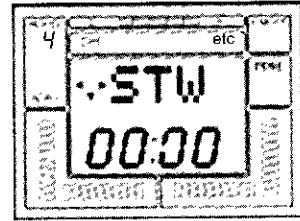
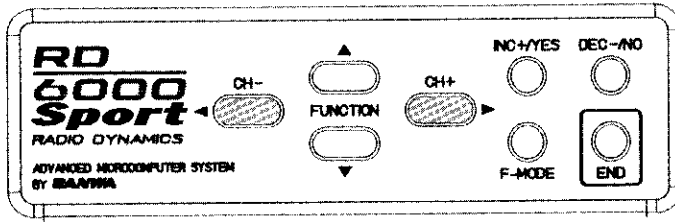

Press the FUNCTION down key to scroll down to the DELTA screen.

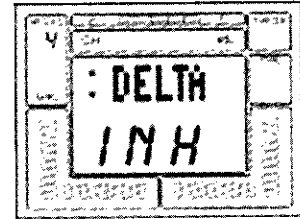
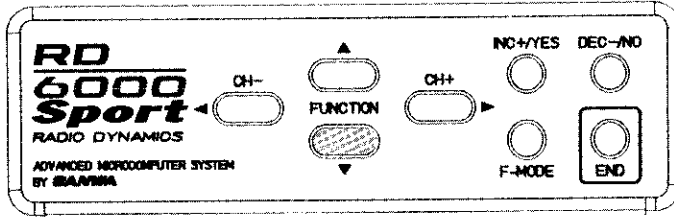

Now press the INC + /YES key to change the display to ACT(Active). Note that you cannot have FLAPE (Flaperon) Active when DELTA is Active and vice versa. When DELTA is Active, you will have two channels assigned for ELEVON control. Plug these two servos into channels #1 and #2 of your receiver. The two servos will now respond to movement of the elevator/aileron control stick. End Point Adjustments for elevator and aileron can then be made for the amount of throw required.

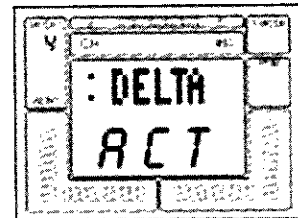
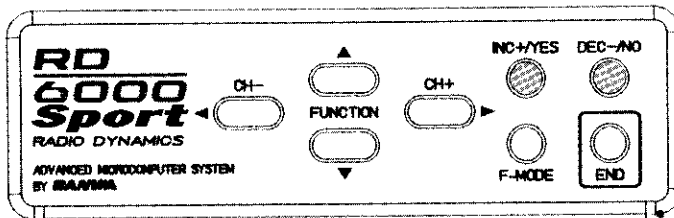

Press the END key to return to the STW screen.

## A>R (AILERON-RUDDER MIX)

The RD6000 Sport provides you with the capability to program your aircraft so that Aileron stick deflection will also cause the rudder servo to respond in the same direction, (right aileron=right rudder). This automatic coordination of rudder with aileron is useful in many high wing/scale models that suffer from adverse yaw with aileron application. (Note that the rudder servo will still respond to rudder stick movement as well as with aileron stick movement).

To use A>R (aileron-rudder) mixing, first access the AL (aileron) channel on the Channel indicator.

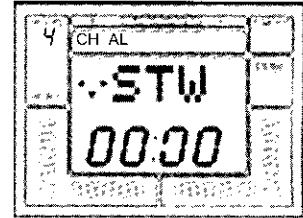
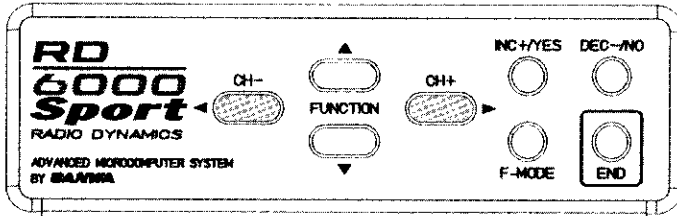

Next, press the FUNCTION down key to select the A>R display.

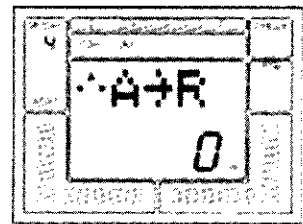
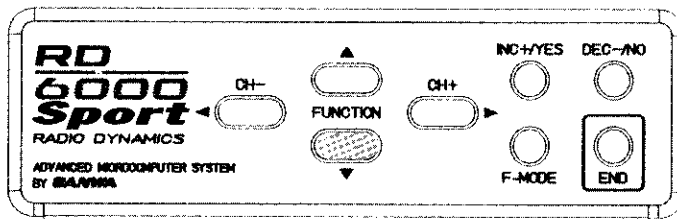

Press the INC +/YES key to adjust the amount of mixing that will occur.

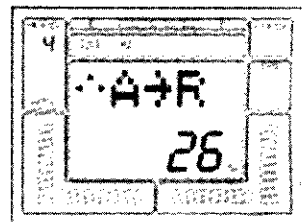
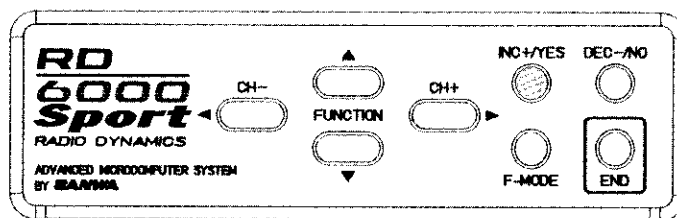

You can now activate the AL>RU mix switch, located above the throttle/rudder stick assembly, to turn-on or off the AL>RU mix function. Press the INC +/YES and DEC -/NO keys simultaneously if you desire to reset A>RU to 0%.

## V-TAIL (RUDDER-ELEVATOR MIX)

The RD6000 Sport transmitter has the ability to control sailplanes or powered models that utilize a V-Tail control system. In these aircraft the two tail controls perform both as elevators and as rudders. Two servos and two channels (receiver channels #1 and #4 are required for V-Tail operation).

To select the V-Tail operation, first press either the < CH - or the CH + > key to access the "etc" channel indicator.

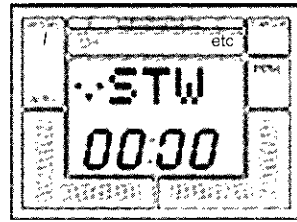
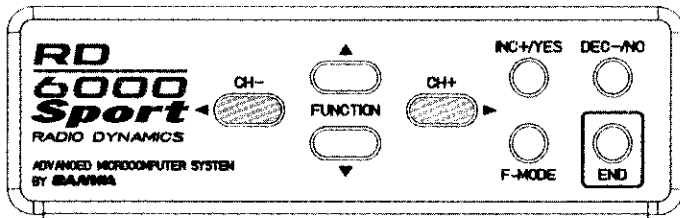

Next, press the FUNCTION down key to scroll down to the V-TAIL display.

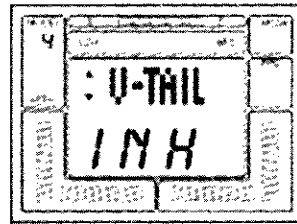
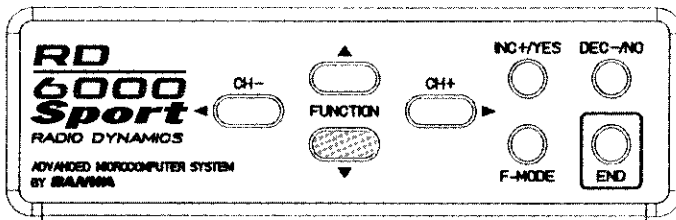

Press the INC +/YES key to see the following screen which will activate the V-TAIL function. If you press the DEC -/NO or the INC +/YES key you can toggle from INH (Inhibit) to ACT (Active). You can use the Rudder and Elevator Servo Rev (Reverse) and EPA (End Point Adjustment) functions to fine tune your set-up.

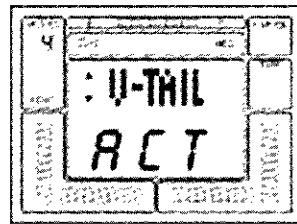
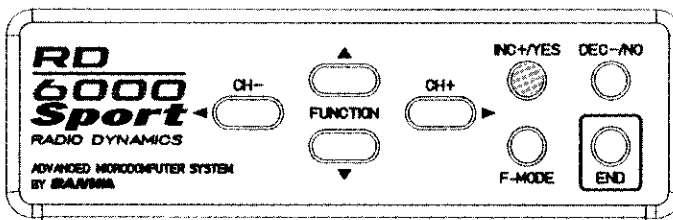

If you desire, you may use the Aileron>Rudder mixing function to allow operation of the V-Tail rudders with the right aileron control stick. See AL>RU mixing, page 42.

## T>E (THROTTLE-ELEVATOR MIX)

The RD6000 Sport allows for automatic adjustment of Elevator trim as you advance or retard the throttle stick. This is a valuable option as most sailplanes will need a change in pitch trim when ever flaps are deployed. By making this adjustment with an electronic mixer, the pilot does not have to alter the elevator digital trims each time flaps are used, and thus does not have to re-trim the elevators for normal flight. This feature can also be used on an engine powered model to make small elevator trim corrections as power is applied or reduced.

To use the T>E (Throttle-Elevator) mix, press either the (CH -) or (CH +) key to select TH on the CH indicator screen. (Note that you must be on the STW screen to move horizontally across the entire CH indicator screen).

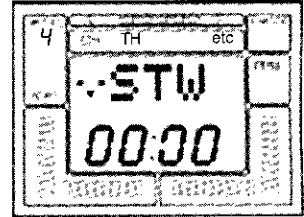
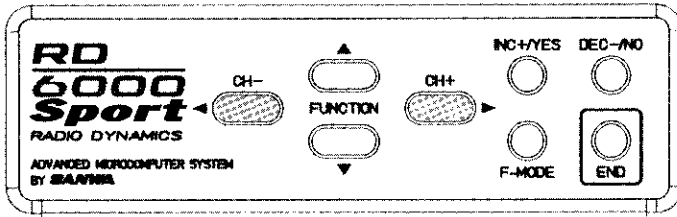

Press the FUNCTION down key to see the following T>E screen.

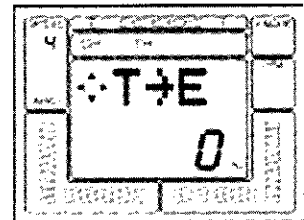
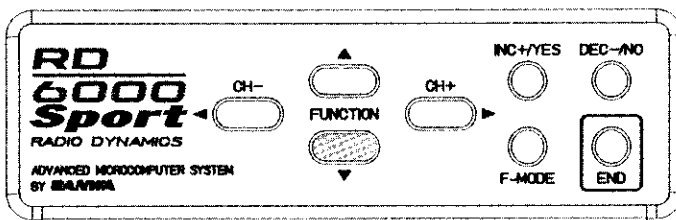

Press the INC +/YES or the DEC -/NO key to set a value for T>E mixing. The range possible is from -100% to +100%. For now in this example, press the INC +/YES key, to insert a value of 20% for the T>E mix. Flight testing will always be required to determine the optimum amount of mix.

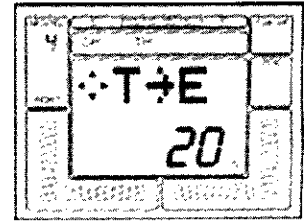
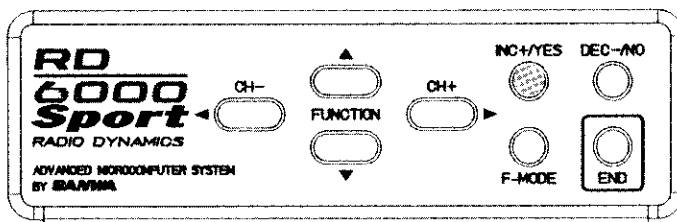

Press the INC +/YES and DEC -/NO keys simultaneously to reset T>E mix to the default value of 0%.

RD6000 Sport USERS MANUAL - HELICOPTER

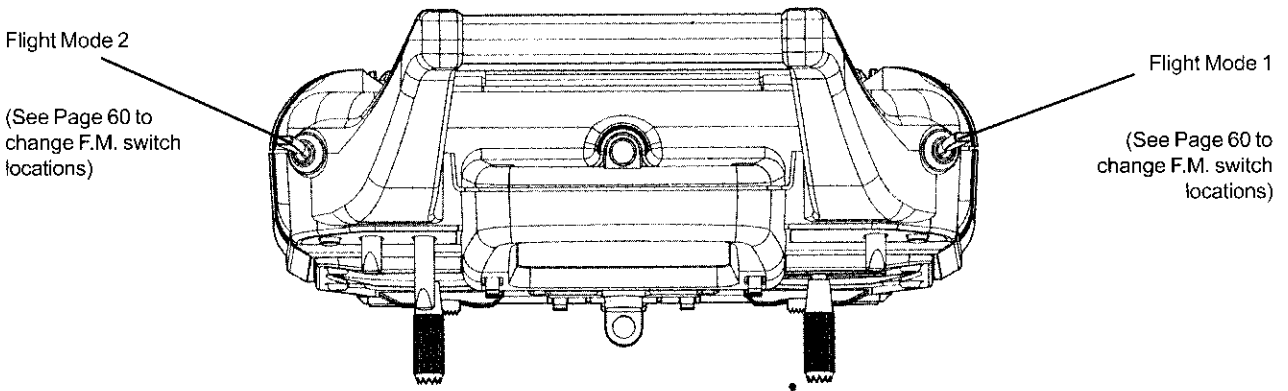
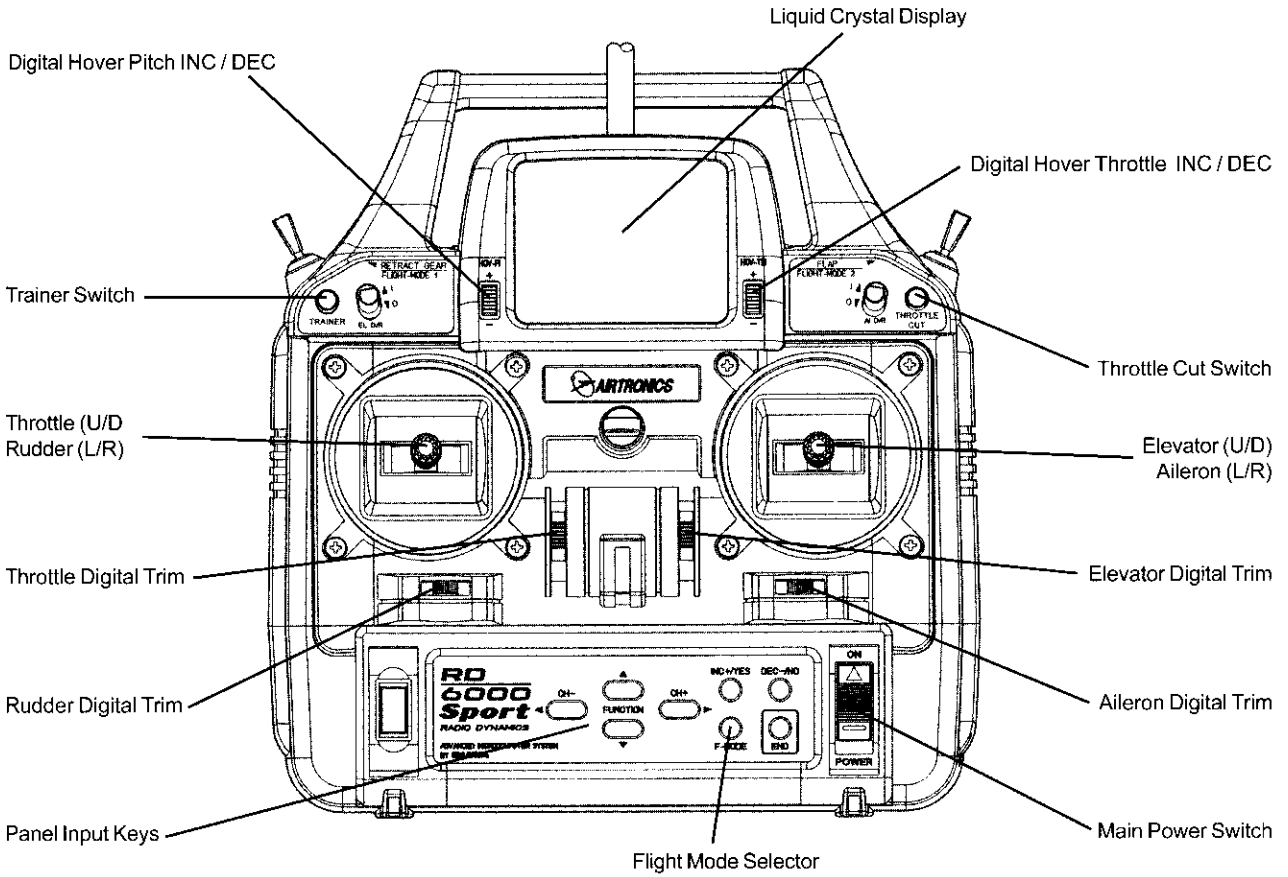

92777 Receiver Channel Assignments	
Receiver Plug Number	Plug in Servo For:
1	Elevator (F/A) Cyclic
2	Aileron (L/R) Cyclic
3	Throttle
4	Rudder (Tail Rotor)
5	Gyro
6	Collective Pitch
7/B	Battery

## HELICOPTER MENU STRUCTURE

(Rx Channel)	CH	EL	AL	TH	RU	G	P/F	etc
		STW	STW	STW	STW	STW	STW	STW
		TRM	TRM	TRM	TRM	REV	REV	M-SL
		REV	REV	REV	REV	GYR	CNT	NAM
		D/R	D/R	CNT	D/R		EPA	STW
		EXP	EXP	EPA	EXP		CV-PH	INT
		CNT	CNT	CV-PH	CNT		CV-P2	TYP
		EPA	EPA	CV-P2	EPA		CV-PL	SW-R
				CV-PL	RV-H			CPY
				T-CUT	RV-M			RST
					RV-L			MOD
								CLK
								DTM

NOTE: Use the (CH-) and (CH+) keys to move horizontally within the same function.  
 Use the FUNCTION UP and FUNCTION DOWN keys to move vertically within the menu.  
 The small triangles to the left of the function that shows on the LCD screen indicates the direction that you can move horizontally and vertically in the menu.

Use the four center buttons in the function panel to navigate through the menu's. (UP / DOWN / LEFT / RIGHT)

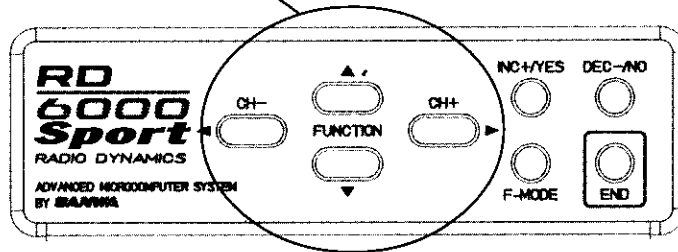

## PROGRAMMING FOR HELICOPTER

### INITIAL SET-UP OF TYP (MODEL TYPE)

When you receive your RD6000 Sport unit the transmitter is preprogrammed for both fixed wing aircraft model's as well as for helicopter models as follows:

- Model #1 is setup with AERO features (AR1)
- Model #2 is setup with HELI features (HL2)
- Model #3 is setup with AERO features (AR3)
- Model #4 is setup with HELI features (HL4)

If you fly only helicopter model aircraft, you can change both model's 1 and 3 to helicopter.

Turn the transmitter power ON and press the END key until you come to the default main screen. The initial screen will show AR1 which indicates the aircraft type as well as showing the NiCd battery voltage.

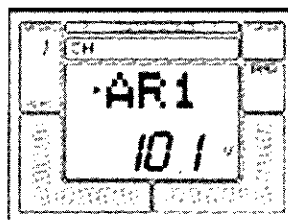
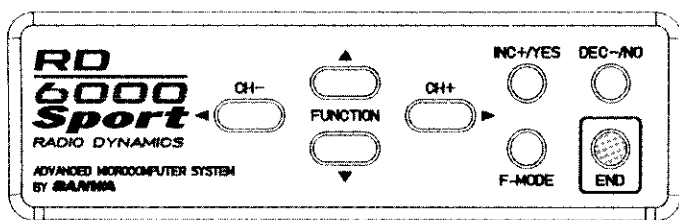

Press the (CH+) key to scroll across the CH (channel) indicator on the screen to "etc".

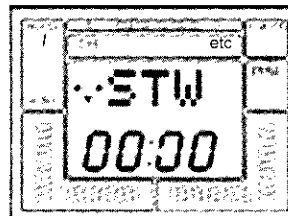
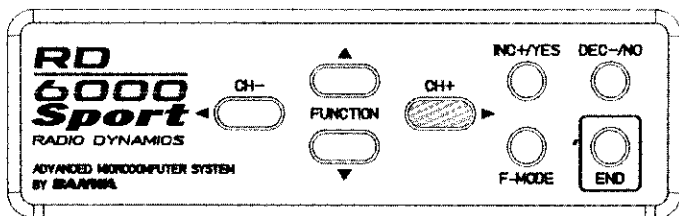

Press the FUNCTION down Key once to access the TYP (model type) screen.

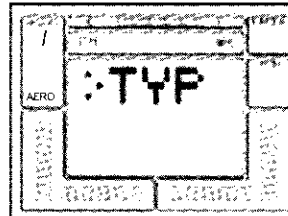
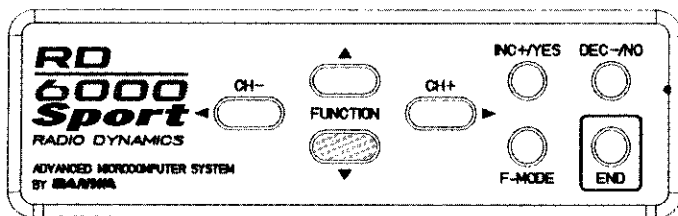



Note that one of the small triangular indicators will be blinking to show that you should press the (CH+) key. Therefore, press the (CH+) key and the screen will change to read HELI with a flashing YES.

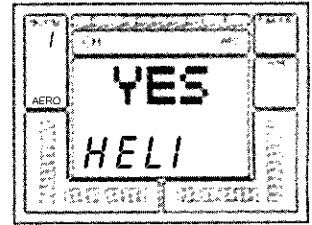
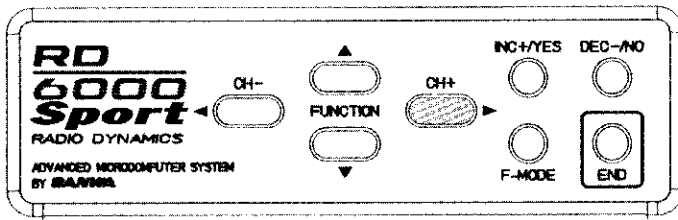

To confirm the change of aircraft type, press the INC+/YES key. The screen will then change to read OK! As shown on screen below to indicate the model type has been changed to AERO from model #2. Press the END key twice to return to the STW screen.

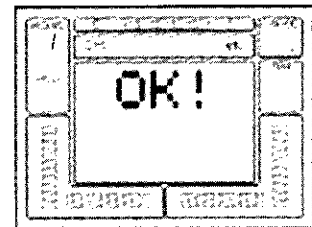
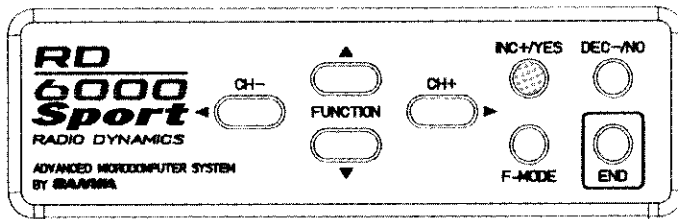

Press the END key twice to return to the STW screen. The same procedure as noted above can be used to change Model #3 from AERO to HELI.

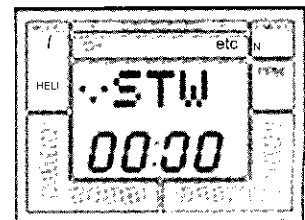
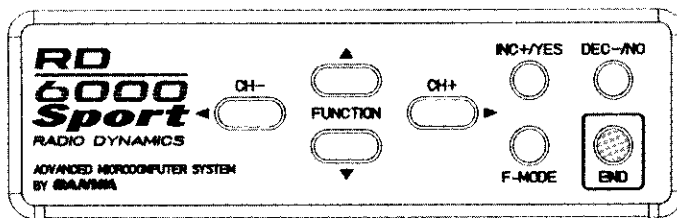

## **PITCH CURVES (FLIGHT MODES)**

The RD6000 Sport allows you to customize three distinct flight modes for each helicopter model.

The three pitch curves (flight modes) available for each helicopter model are:

- N.....NORMAL
- 1.....Select Curve One – IDLE UP
- 2.....Select Curve Two – THROTTLE HOLD

Selecting a pitch curve is done by activating the two FLIGHT MODE switches located on the top of the transmitter as shown below. The default positions are as indicated.

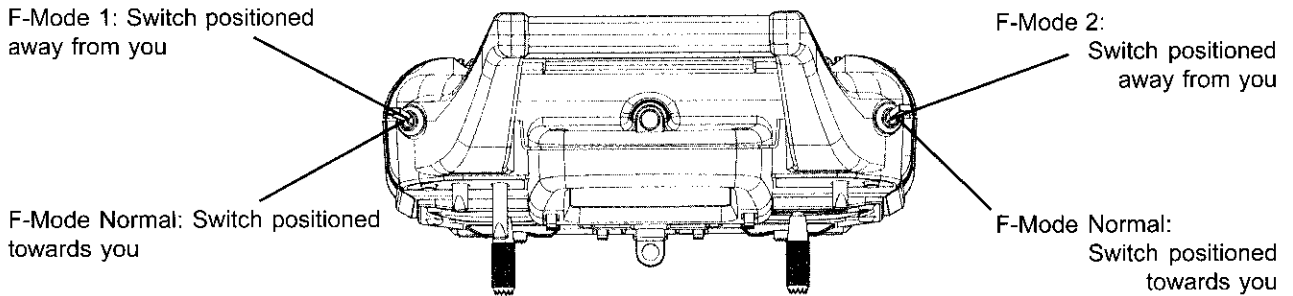

Note that BOTH F-MODE switches must be positioned towards you to select F-MODE NORMAL.

**CAUTION:** Flight Modes 1 and 2 are IDLE-UP modes. If either one is activated when you turn on the transmitter, an audio alarm will sound. You must always be aware of which flight mode you have selected before starting your engine or attempting flight!

The pitch curve for each flight mode has three points that can be adjusted to suit your specific needs. Within each pitch curve these points are referred to as PH (high pitch), P2, and PL (low pitch). The range of values and default settings for each is shown below.

FLIGHT MODE	Curve Point	Minimum	Default	Maximum
Normal	PH	-25%	100%	125%
	P2	-25%	55%	125%
	PL	-25%	0%	125%
F. Mode 1	PH	-25%	90%	125%
	P2	-25%	55%	125%
	PL	-25%	0%	125%
F. Mode 2	PH	-25%	100%	125%
	P2	-25%	40%	125%
	PL	-25%	-10%	125%

To program your pitch curves, press the (CH -) or (CH +) key to select P-F on the Channel indicator.

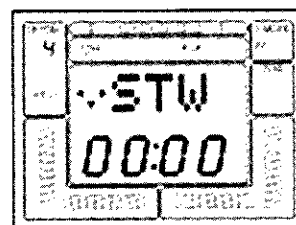
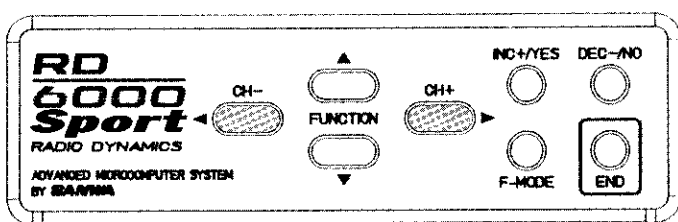

Next, press the FUNCTION down key and scroll down to the CV-PH screen.

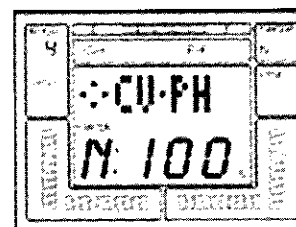
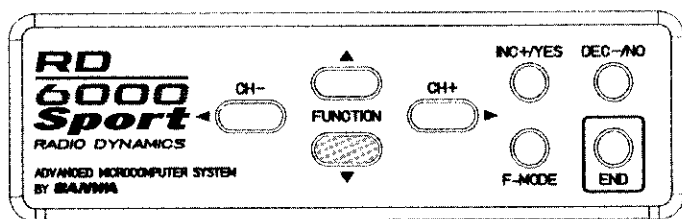

Press the F-MODE (flight mode) switch to toggle through modes 1, 2 and Normal.

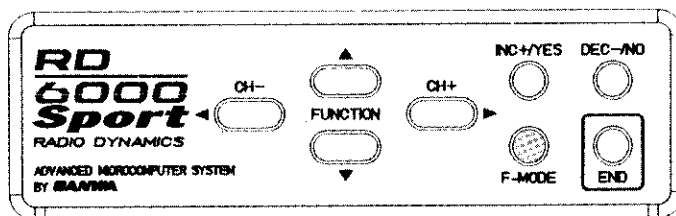

Now use the F-MODE switch to select the specific flight mode that you want to adjust. As an example, if you wanted to adjust CV-P2 in Normal flight mode, press the FUNCTION down key to select CV-P2. The default value for the Normal flight mode of 55% will be shown.

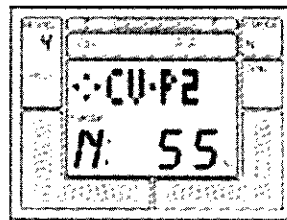
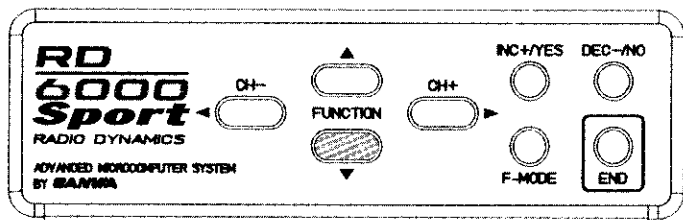

Press the INC+/YES key to set an increase in value or press the DEC-/NO key to set a lesser value. Press both INC+/YES and DEC-/NO keys simultaneously to return to the default value.

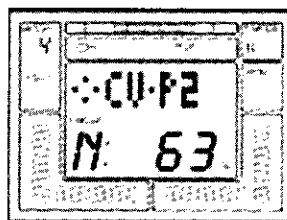
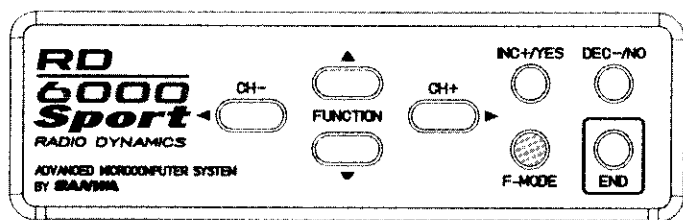

Fine tuning of the Hover Pitch is also available by use of the HOV-PT digital trim switch located above the throttle stick. NOTE: HOV-PI and HOV-TH trims are used only for adjustment in flight mode N (normal). They have no effect on Flight Mode 1 or 2.

HOV-PI + -  
Digital Trim

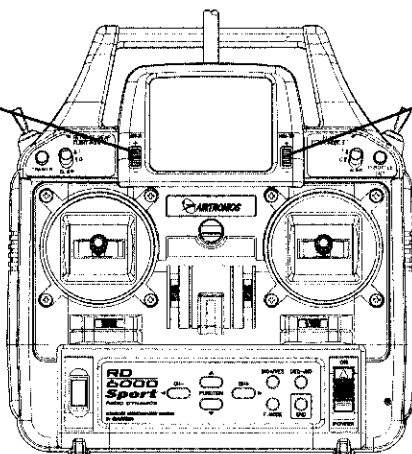

HOV-TH + -  
Digital Trim

In normal operation you will usually set the approximate Hovering Pitch with the software in the Pitch screens then adjust as needed for various weather and flying conditions with the HOV-PI (hover pitch) digital trim switch.

## THROTTLE CURVES (FLIGHT MODES)

The throttle curve for each flight mode has three points that can be adjusted to suit your specific needs. Within each throttle curve these points are referred to as PH (high pitch) P2, and PL (low pitch). The range of values and default settings for each is shown below.

FLIGHT MODE	Curve Point	Minimum	Default	Maximum
Normal	PH	-25%	100%	125%
	P2	-25%	50%	125%
	PL	-25%	0%	125%
F. Mode 1	PH	-25%	100%	125%
	P2	-25%	50%	125%
	PL	-25%	0%	125%
F. Mode 2	PH	-25%	0%	125%
	P2	-25%	0%	125%
	PL	-25%	0%	125%

To program your throttle curves, press the (CH -) or (CH +) key to select P-F on the CHannel indicator.

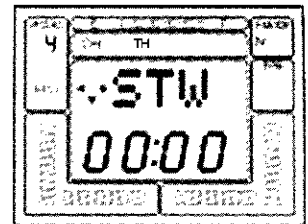
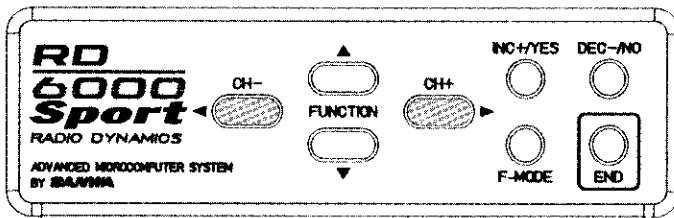

Next, press the FUNCTION down key and scroll down to the CV-PH screen.

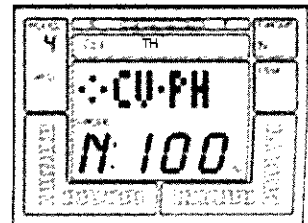
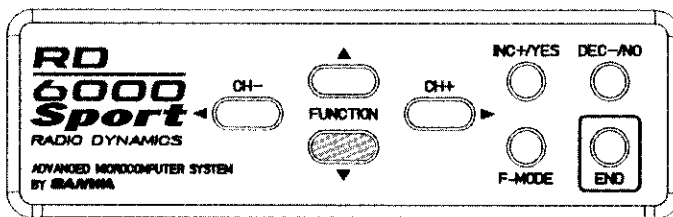

Press the F-MODE (flight mode) switch to toggle through modes 1, 2 and Normal.

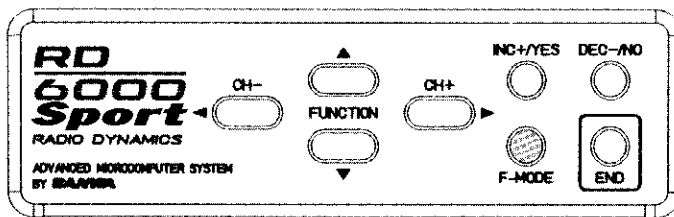

Now use the F-MODE switch to select the specific flight mode that you want to adjust. As an example, if you wanted to adjust CV-P2 in Normal flight mode, press the FUNCTION down key to select CV-P2. The default value for the Normal flight mode of 50% will be shown.

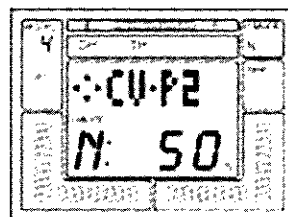
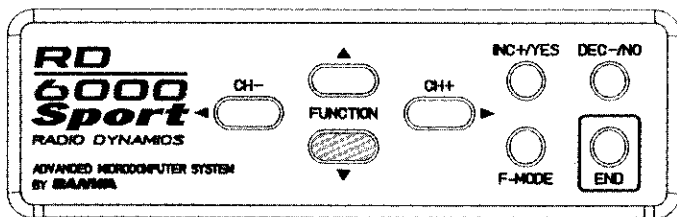

Press the INC+/YES key to set an increase in value or press the DEC-/NO key to set a lesser value. Press both INC+/YES and DEC-/NO keys simultaneously to return to the default value.

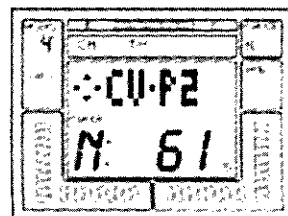
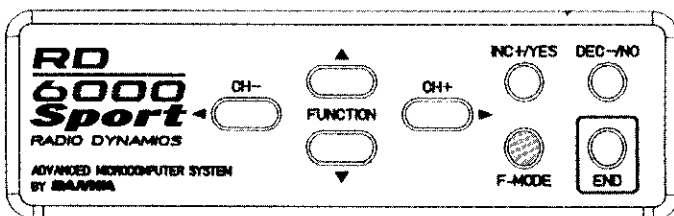

Fine tuning of the Hover Throttle is also available by use of the HOV-TH digital trim switch located above the elevator stick.

## REVOLUTION MIXING

The RD6000 Sport provides for setting Revolution Mixing for each of the three Flight Modes. Each Flight Mode has its own curve for adjusting tail rotor position in response to the throttle/collective stick movements. The default settings for RV.H (Revolution Mixing High Point), RV.M (Revolution Mixing Mid Point), and RV.L (Revolution Mixing Low Point) are as follows:

FLIGHT MODE	RV.H	RV.M	RV.L
Normal	20%	0%	-20%
F. Mode #1	0%	-2%	-5%
F. Mode #2	0%	0%	0%

To program Revolution Mixing, press either the (CH -) or (CH +) key to select RU ( rudder) on the CHannel indicator.

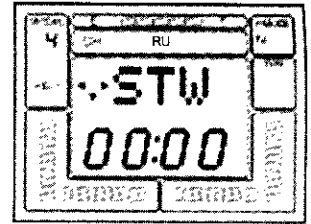
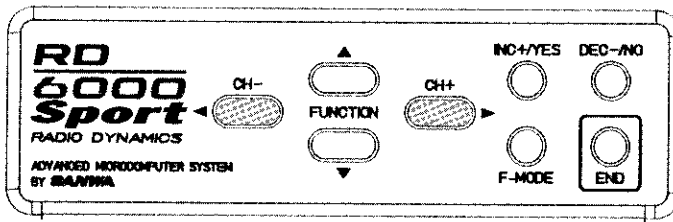

Next, press the FUNCTION V key to select RV.H which is the revolution mixing high point.

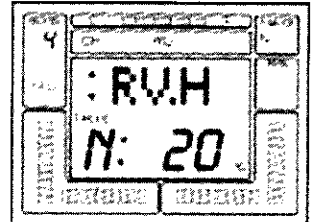
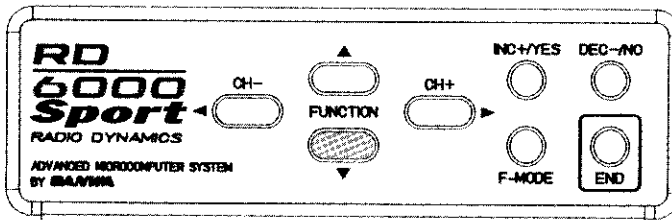

Use the INC +/YES or DEC -/NO key to change the default value if you desire to do so for any of the three flight modes. In this example we have set RV.H for the Normal flight mode to + 25%.

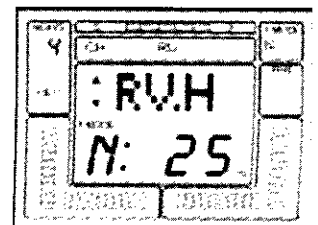
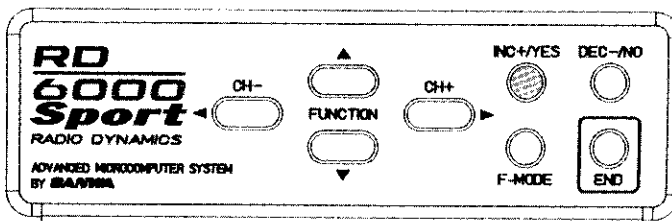

The same procedure can be used to input values for RV.M and RV.L. Press the Flight Mode switch to select the different Flight Modes.

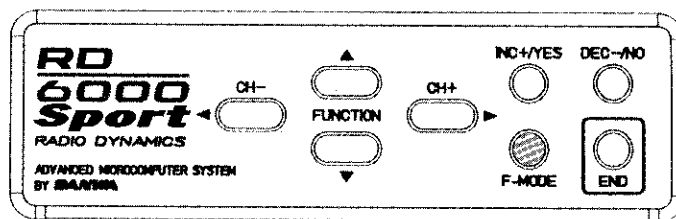

## GYRO ADJUSTMENT

The RD6000 Sport allows you to set the Gyro sensitivity of your helicopter's gyro if it has that capability. The gain of the gyro can therefore be adjusted for all of the three Flight Modes. In this manner the pilot can adjust the gyro for a suitable level of sensitivity (gain) for one flight mode (for instance hover), and by changing to a different flight mode alter the sensitivity for either more or less stabilization. Note that you must be using a gyro that offers remote sensitivity adjustment.

Press either the (CH -) or the (CH +) key to select G (Gyro) on the CHannel indicator.

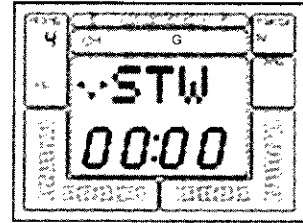
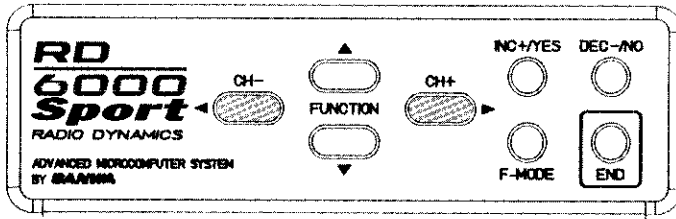

Now, press the FUNCTION down key several times to access the GYR (gyro) screen. The display will look like the following screen when the Normal flight mode is selected.

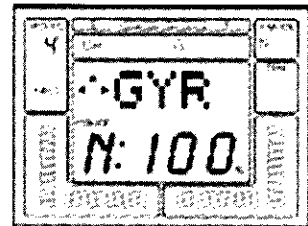
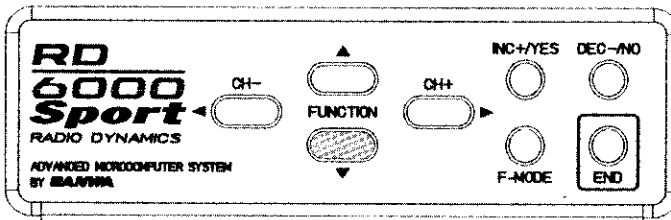

To adjust the gyro sensitivity for a specific flight mode, press either the INC +/YES or DEC- /NO key. Default values are : Normal 100%, F.Mode #1 50%, and F.Mode #2 100%. The range of adjustment is from - 150% to + 150%. Press the Flight Mode switch to change from one flight mode to another.

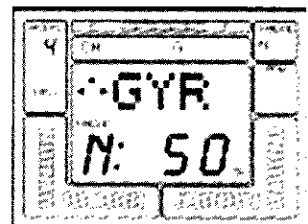
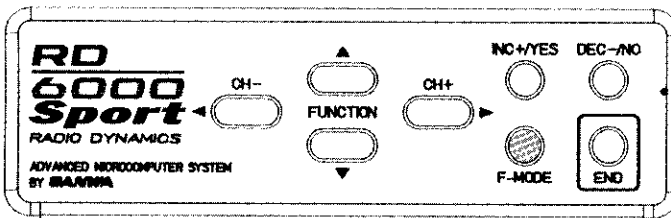

Fine tuning of your gyro sensitivity for the various flight modes can be accomplished by flight tests.



## TRM (TRIM MEMORY)

The RD6000 Sport offers the Trim Memory Function on all four of the flight control channels. Trim Memory for Elevator, Aileron, Throttle, and Rudder is input by the Digital Trim keys set when you use the INC +/YES or DEC -/NO keys to input trim.

Any trim that you set while your model is in flight by use of the Digital Trim keys will automatically be stored in memory for that specific channel and model.

The Trim value in % that you set during flight is shown on the TRM screen for each Channel. In addition, there are bar graph indicators on the screen at all times that visually show how much trim has been set for Elevator, Aileron, Throttle and Rudder channels.

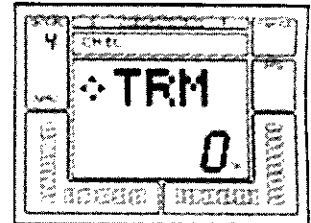
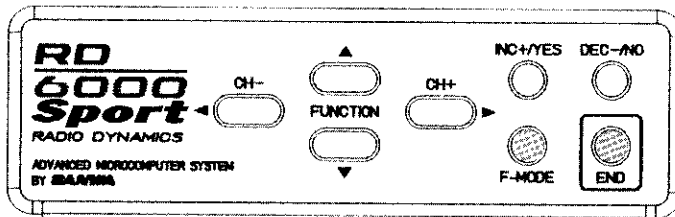

## D/R (DUAL RATE)

Dual Rate adjustments allow you to switch from your "standard" control deflection to a reduced amount of throw by using your flight mode switches. The actual speed of signal processing and servo movement are not affected by the Dual Rate settings, only the amount of total throw available.

The RD6000 Sport allows Dual Rate settings for Aileron, Elevator and Rudder. To access the Dual Rate setting for Elevator when you are on the STW or REV screen, press the FUNCTION down key to reach this screen.

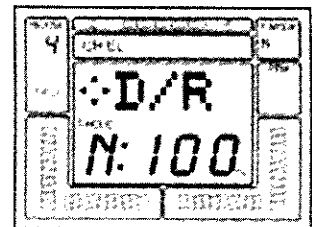
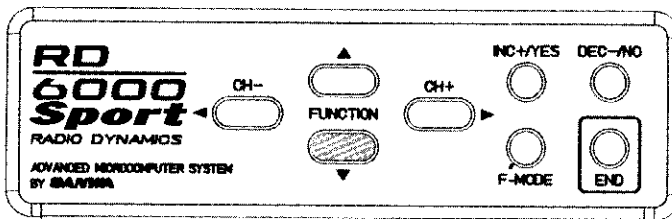

The screen tells you the present rate status and the flight mode that you have selected. It is important to understand that the term "Dual Rate" is used because it is an old familiar description. We are showing an example for the Elevator channel. However, all of the other channels are set in the same way.

Dual Rate settings can be varied from 0 to 150% for each flight mode, N, 1 and 2. Default for all flight modes are at 100%.

An initial setting of 50% is a good starting point and you can tailor it later following a test flight.

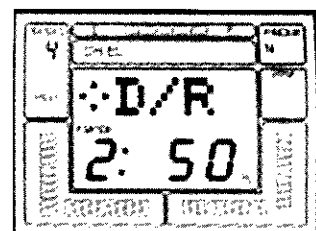
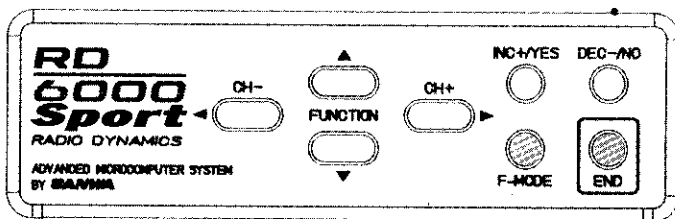

**CAUTION:** Prior to taking off your model, check the positions of your flight mode switches and make sure they are in the position you want.

## DTM (DYNAMIC TRIM MEMORY)

Dynamic Trim Memory (DTM) is an advanced function that can be used in conjunction with the Flight Mode OPTIONS. When activated Dynamic Trim Memory allows you to make trim changes while in any flight mode WITHOUT affecting any other flight mode or model.

Flight Modes are used to allow activation of the DTM function. The three flight modes are:

NORMAL  
F.M. #1.....IDLE-UP  
F.M. #2.....THROTTLE-HOLD

Activating DTM will allow trim changes made in one flight mode to affect ONLY that specific mode. To activate Dynamic Trim Memory, press the (CH +) or the (CH -) key to select "etc" on the CHannel indicator.

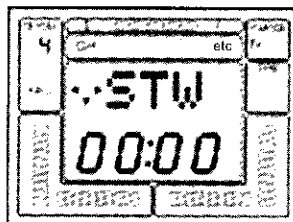
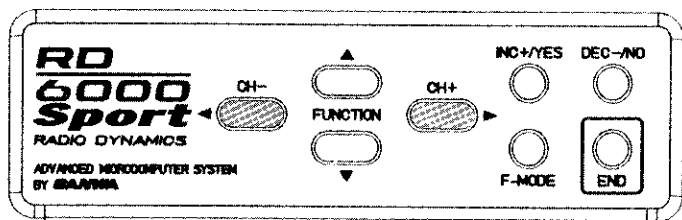

Now, press the FUNCTION down key to scroll down the menu to the DTM screen.

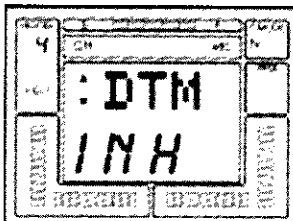
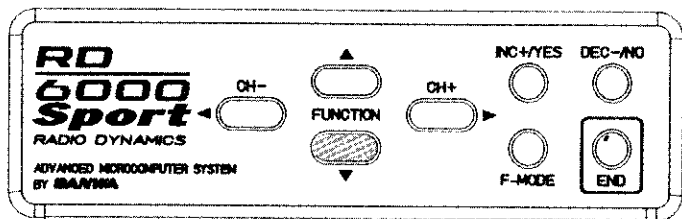

Press the INC +/YES or the DEC -/NO key to change DTM to ACT (active). Pressing either key will toggle the indication from ACT to INH. Press the END key to return to the STW screen.

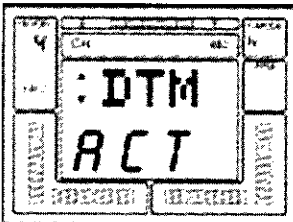
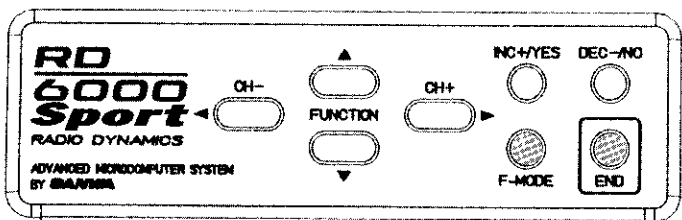

Once activated, the Dynamic Trim Memory function is transparent to the pilot. Simply activate a Flight Mode, (for instance "Normal") and trim the aircraft for stable hover using the digital trim keys. Then, switch to another flight mode, and do the same as desired. Note that when you change flight modes, the servos affected by the DTM function will return to the original neutral position regardless of the value of trim set-in for the previous flight mode. However, the throttle channel is an exception to the rule. The trim that is set for one flight mode will affect all other flight modes. Also be aware that the throttle trim key only affects the low throttle position of the throttle servo. Throttle trim DOES NOT affect the collective pitch servo.

## COMPENSATION MIXERS (C-Mix)

The RD6000 Sport has two compensation mixers available to handle advanced mixing needs. These are in addition to the predefined mixers. Compensation mixers C-Mix 1 and C-Mix 2 are only available in the Aircraft mode of operation and do not have any switch to turn them on or off when activated.

The purpose of a Compensation Mixer is to allow one transmitter control input to affect two flight functions. A common mix would be Aileron to Rudder to achieve coordinated turns without moving the rudder stick. However, the RD6000 Sport provides a predefined mixer for this function.

Press the (CH+) key to move across the CH indicator and access the "etc" screen. Next press the FUNCTION down key and locate the following screen names in order:

MAS 1: EL = (C-Mix #1 Master channel) *example EL "Elevator"*  
SLV 1: EL = (C-Mix #1 Slave Channel) *example EL "Elevator"*  
E>E 1: 0% = ( C-Mix #1 mixing percentage) Adjust from +150% ~ -150% *example "Elevator to Elevator"*

MAS 2: EL = (C-Mix #1 Master channel) *example EL "Elevator"*  
SLV 2: EL = (C-Mix #1 Slave Channel) *example EL "Elevator"*  
E>E 2: 0% = ( C-Mix #1 mixing percentage) Adjust from +150% ~ -150% *example "Elevator to Elevator"*

### NOTE:

At this point, both C-Mix 1 and C-Mix 2 are not activated (factory default).

To activate both C-Mix 1 and C-Mix 2 you must first change the (SW-R) from NOR (normal) to REV (reverse). See page number 27 on how to change.

### REMEMBER:

When you activate both C-Mix 1 and C-Mix 2, they both will be on all the time, there is no toggle switch to turn them off or on. Any number besides "0" in the percentage screen will cause the slave channel to move in either direction.

Changing the SW-R (switch reverse) will also change the switch direction or both your Dual Rate switches and will reverse the direction of your Gear and Flap switches. If you have setup any of the features mentioned, please review your settings before flying.

In the following example, I will use C-Mix 1 to mix Rudder to Elevator as maybe needed for knife edge flight.

Start by pressing the (CH+) key until you reach "etc" .

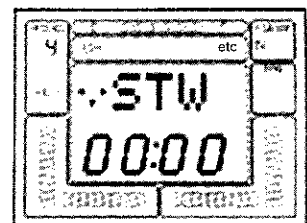
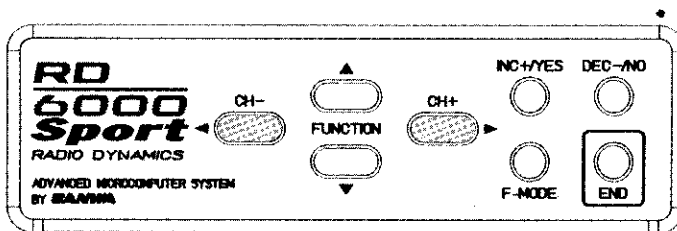

Now use the FUNCTION down key until you reach the (MAS 1:) screen. Next use the INC or DEC keys until the RU (rudder) is selected. This will be your Master channel.

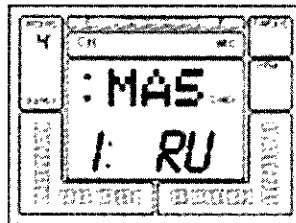
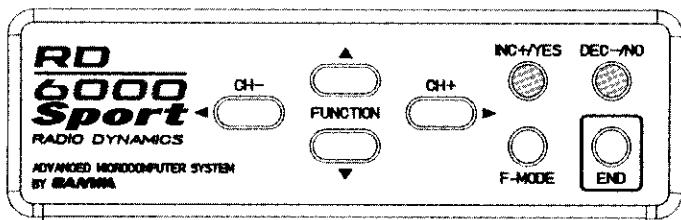

Next press the FUNCTION down key ones to select (SLV 1:) screen. Now use the INC or DEC keys until you reach EL (elevator). This will be your Slave channel.

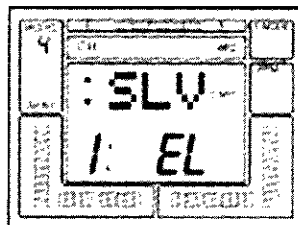
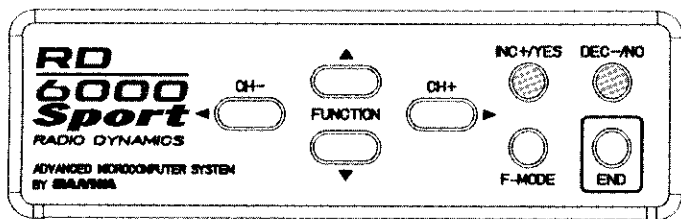

Next press the FUNCTION down key ones to select (R>E 1:) screen.

By moving the Rudder stick you will see the arrow indicators on the screen change directions according to the direction you move the stick, left and right. You can set the C-Mix for both directions independently. For example, when you are in a knife-edge and you give it right rudder but the plane pulls to the top of the aircraft you can simply moved the stick to the right and press the INC or DEC keys and observe the elevator movement. If by increasing the number moves the elevator in the wrong direction, you can decrease the number into the negative side to change the direction of the compensation. Only use a small amount of compensation at first. You can set the left compensation in the same manner if any compensation is needed.

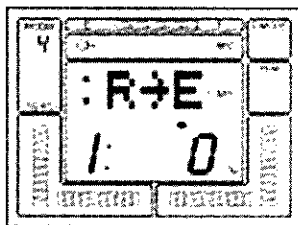
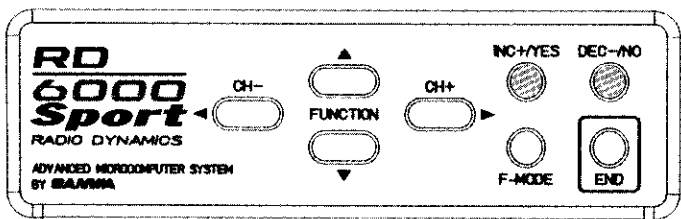

REMEMBER: When activated, C-Mix 1 and 2 will be on at all times.

When the C-Mix percentages in both directions are at "0", there will be no compensation mixing.

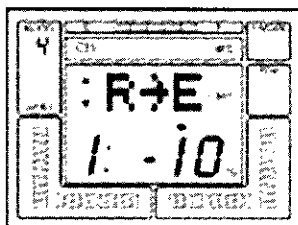

## CHANEING FLIGHT MODE 1 and 2 Switch Locations

From the factory flight mode 1 switch is on the right top toggle and flight mode 2 is on the left top toggle switch. Some fliers prefer on having flight mode 1 switch on the left top and flight mode 2 on the right top switch. The following will be on how to change flight mode 1 and 2 switch locations.

- 1 Remove the NiCd battery cover and NiCd battery pack.
- 2 Remove the antenna by unscerwing it counter clockwise.
- 3 Remove all 8 scerws located on the back of the transmitter. Refer to page 10 for screw locations.
- 4 Remove both left and right switch retainer nuts located on top of the switches (crome)
- 5 Cut both left and right wire tie's off holding the wiring to both switches.
- 6 With a black marker pin put a dot on the plastic base of the switch to indecate the rear of the switch. This will help to not mistakenly flip the switch over.
- 7 Remove both switches by sliding them down into the transmitter case and switch locations.
- 8 Reinstall both switch (crome) nuts and secure in place.
- 9 Arange both switch wires away from any moving parts and secure with new wire tie's making sure the wires will not get in the way of the antenna as it is being reinstalled.
- 10 Reinstall the transmitter rear case and be careful when placing over ther NiCd battery connector pins.
- 11 Reinstall all 8 case scerws.
- 12 Reinstall Antena by screwing clockwise.
- 13 Reinstall the NiCd battery and battery Cover.

Before

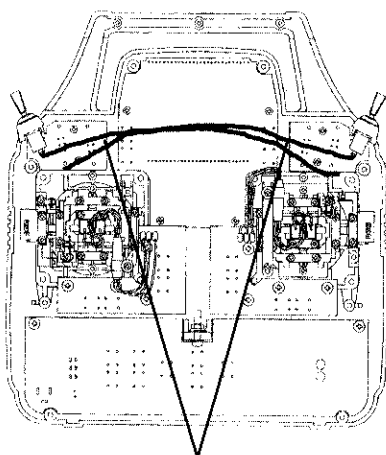

Wire Tie locations

After

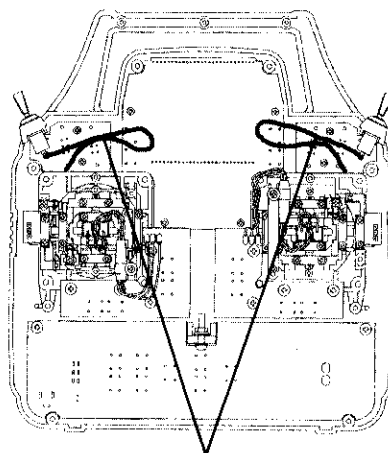

Wire Tie locations

After you have completed the switching over of both flight mode 1 and 2 switches, you can now replace the two front switch identifying labels. (new labels are supplied)

Use a small scerw driver to pry up the old label to remove. Be carfull not to damage the plastic transmitter case. Next pell the backing off the new label and secure in place.

New switch location labels

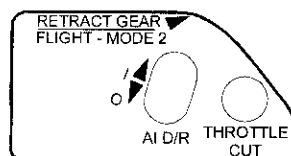
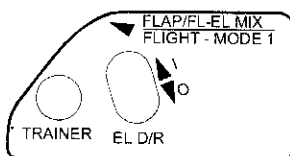

### WARNING:

Any other modifications made to the transmitter other than changing the flight mode switch locations will void any and all warranties covered be Airtronics Inc.

MODEL #.....MODEL NAME.....

WING TYPE	NORMAL	DELTA	V-TAIL	FLAPERON
	FLAPERON & V-TAIL			

CH	(1) EL	(2) AL	(3) TH	(4) RU	(5) G	(6) F
TRM	%	%	%	%		%
REV	NOR / REV	NOR / REV	NOR / REV	NOR / REV	NOR / REV	NOR / REV
D/R	1	%	%			
	2	%	%			
EXP	1	%	%			
	2	%	%			
CNT	%	%	%	%		%
EPA	↑ UP	% ← LT	% ↑ HI	% ← LT	% ↑ HI	%
	↓ DN	% → RT	% ↓ LO	% → RT	% ↓ LO	%
MIX		A > R				T > E
		%				%
T-CUT	STW	SW-R	D/R-A			
%	:	NOR / REV	INH / ACT			

MODEL #.....MODEL NAME.....

CH		(1) EL	(2) AL	(3) TH	(4) RU	(5) GY	(6) PI	
TRM	N	%	%		%	/	/	
	DTM ACT	1	%	%	%			%
		2	%	%				%
REV		NOR / REV	NOR / REV	NOR / REV	NOR / REV	NOR / REV	NOR / REV	
D/R	N	%	%	/	%	/	/	
	1	%	%		%			
	2	%	%		%			
EXP	N	%	%	/	%	/	/	
	1	%	%		%			
	2	%	%		%			
CNT		%	%	%	%	/		
EPA	↑ UP  ↓ DN	← LT  → RT	↑ HI  ↓ LO	← LT  → RT	%  %  %	N	%	↑ HI  ↓ LO
						1	%	
						2	%	

TH-CV	/		PL	P2	PH
	N		%	%	%
	1		%	%	%
	2		%	%	%

T-CUT	%
STW	:
SW-R	NOR/ REV
DTM	INH/ REV

PI-CV	/		PL	P2	PH
	N		%	%	%
	1		%	%	%
	2		%	%	%

REV	/		PL	P2	PH
	N		%	%	%
	1		%	%	%
	2		%	%	%